

Pelsan

İç Mekan
Aydınlatma

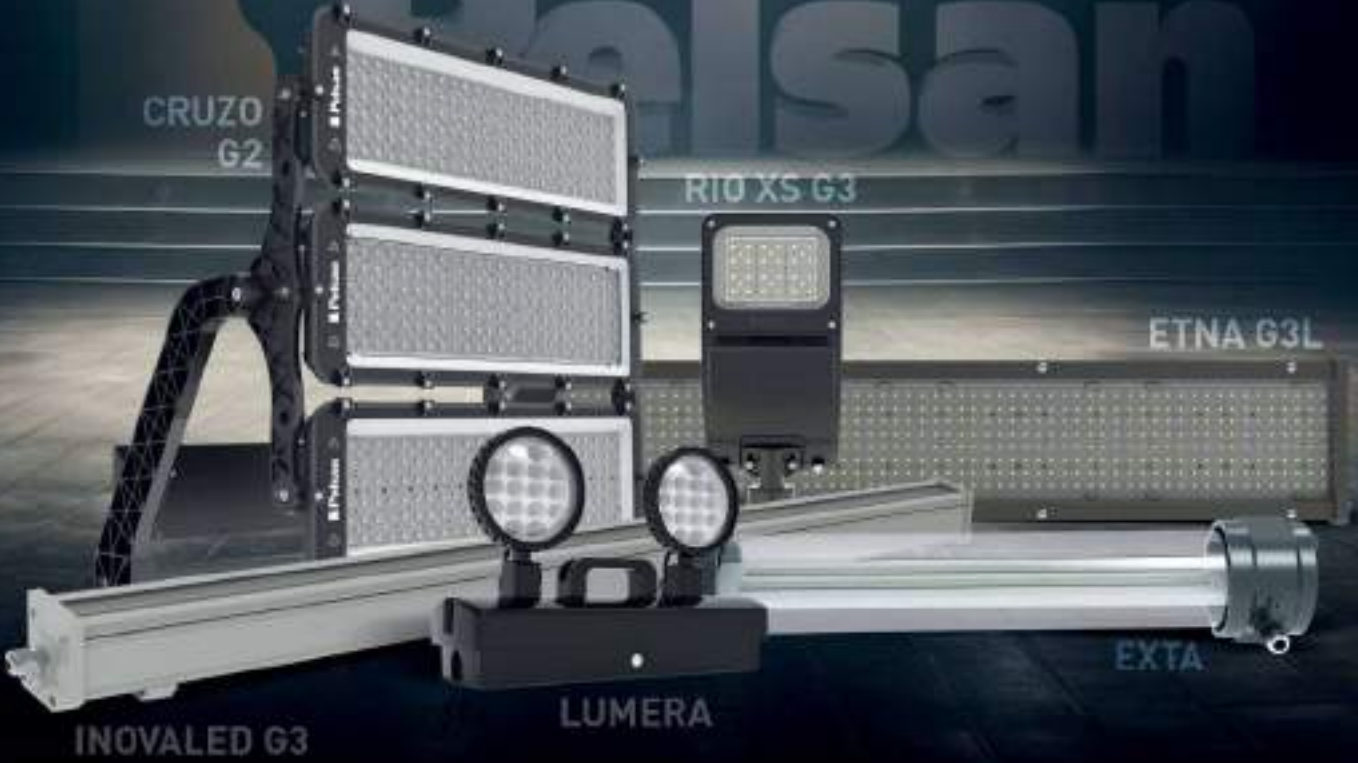





Endüstriyel
Aydınlatma

Dış Mekan
Aydınlatma



2025/1
FİYAT LİSTESİ



-  IP66, Toz ve su almaz
-  Yıkabilir, solvante dayanıklıdır
-  Hava ventilli rakoru ile nem yapmaz
-  Sürekli üstün performans
-  Difüzörü asla sararmaz
-  Işığı istediği noktaya yönlendirme
-  Geniş lümen paketi, 2033-18750lm



Zone1, Zone21 ATEX Belgeli Ex-Proof Armatürler

Pelsan

- Gaz Patlama Koruması: Zone 1
- Toz Patlama Koruması: Zone 21



Atarex

Projektör / Yüksek Tavan

- Gaz Patlama Koruması: Zone1
- Toz Patlama Koruması: Zone21
- II 2G Ex eb db IIB T4-T6 Gb
- II 2D Ex tb IIIC T130° -85° C Db



Exta

Etanj / Yüksek Tavan

- Gaz Patlama Koruması: Zone1
- Toz Patlama Koruması: Zone21
- II 2G Ex db IIB T6 Gb
- II 2D Ex tb IIIC T85° C Db

Ex-Proof Zone1, Zone21
Sayfa 40



Diğer Ex-Proof Armatürleri



Largo LED
Etanj Armatür



Nairo
Projektör

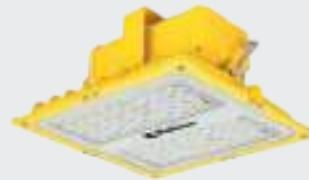

Sia
Yüksek Tavan Armatürü



Nairo
Yol ve Cadde Armatürü

2025/1

İçindekiler



06

Backlight Ofis Armatürleri



07

Backlight Ofis Armatürleri



08

Sıva Altı Ofis Armatürleri

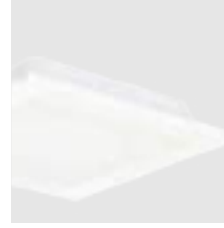

09

Clip-in Ofis Armatürleri



10

Sıva Üstü Ofis Armatürleri



12

Lineer Armatürler



14

Downlight Armatürler



18

İç Mekan Glop



19

Tavan Duvar Armatürleri

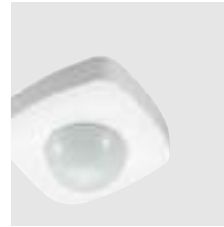

20

Sensörler



22

Acil Aydınlatma
Armatürleri



25

Acil Yönlendirme
Armatürleri



27

Taşınabilir
Güç Kaynağı



28

Etanj
Armatürler



31

LED Tube'ler
LED Tube Etanj



32

24Vac/dc
110Vac Armatürler



33

Benzinlik
Armatürleri



34

Yüksek Tavan
Armatürleri

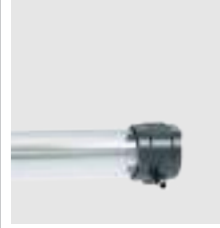

40

Ex-Proof
Armatürler



43

Wallwasher



44

Yüksek Güçlü
Projektörler



46

Projektörler



49

Yol ve Cadde
Armatürleri

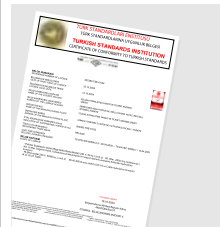

51

Sertifikalar

Profesyonel Çözüm Isoled G3T

Isoled

5
YIL
GARANTİ

TSE
TSE Belgeli



Avrupa Menşei ENEC Belgeli Sürücü



113 lm/W'a Varan Verimlilik



50.000 Saat Ömür



Tarak PCB



PF > 0,95



PMMA Difüzör



55mm Kasa Kalınlığı



Isoled 60x60

Sıva Altı

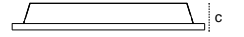

Kod	Güç (W)	Renk Sıcaklığı (K)	Işık Akısı (lm)	Etkinlik Faktörü (lm/W)	Boyutlar (mm)axbxc	Kesim Ölçüsü (mm)	Koli Ağırlığı (kg)	Koli Adedi	Fiyat
111411	36	4000	4068	113	595X595x61	570x570	23,5	6	43,75\$
111412	36	6500	4068	113	595X595x61	570x570	23,5	6	43,75\$

Özellikler	Metal	Opal Difüzör	3000/4000/6500K	IP40	50.000h	5 Yıl
Opsiyonlar	DALI	1-10V	Acil Aydınlatma (1-3 saat)	Clip-in	Alçıpan	



Isoled 30x30

Sıva Altı

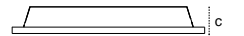

Kod	Güç (W)	Renk Sıcaklığı (K)	Işık Akısı (lm)	Etkinlik Faktörü (lm/W)	Boyutlar (mm)axbxc	Kesim Ölçüsü (mm)	Koli Ağırlığı (kg)	Koli Adedi	Fiyat
111342	12	4000	1236	103	295x295x61	270x270	7	5	23,00\$
111343	12	6500	1236	103	295x295x61	270x270	7	5	23,00\$

Özellikler	Metal	Opal Difüzör	3000/4000/6500K	IP40	50.000h	5 Yıl
Opsiyonlar	DALI	1-10V	Acil Aydınlatma (1-3 saat)	Clip-in	Alçıpan	



Isoled 30x60

Sıva Altı

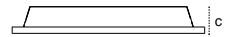

Kod	Güç (W)	Renk Sıcaklığı (K)	Işık Akısı (lm)	Etkinlik Faktörü (lm/W)	Boyutlar (mm)axbxc	Kesim Ölçüsü (mm)	Koli Ağırlığı (kg)	Koli Adedi	Fiyat
111461	17	4000	1785	105	595x295x61	570x270	12,54	5	36,75\$
111462	17	6500	1785	105	595x295x61	570x270	12,54	5	36,75\$

Özellikler	Metal	Opal Difüzör	3000/4000/6500K	IP40	50.000h	5 Yıl
Opsiyonlar	DALI	1-10V	Acil Aydınlatma (1-3 saat)	Alçıpan		



Isoled 30x120

Sıva Altı

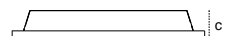

Kod	Güç (W)	Renk Sıcaklığı (K)	Işık Akısı (lm)	Etkinlik Faktörü (lm/W)	Boyutlar (mm)axbxc	Kesim Ölçüsü (mm)	Koli Ağırlığı (kg)	Koli Adedi	Fiyat
111464	36	4000	3960	110	1195x295x61	1170x270	12,8	4	57,00\$
111465	36	6500	3960	110	1195x295x61	1170x270	12,8	4	57,00\$

Özellikler	Metal	Opal Difüzör	3000/4000/6500K	IP40	50.000h	5 Yıl
Opsiyonlar	DALI	1-10V	Acil Aydınlatma (1-3 saat)	Alçıpan		

Opsiyonlar

Kod	Özellikler	Koli Adedi	Fiyat
327764	Isoled & Dekoled Acil Aydınlatma Kit Opsiyonu (1 saat)	1	27,60\$
333852	Isoled & Dekoled Acil Aydınlatma Kit Opsiyonu (3 saat)	1	31,60\$
323795	Isoled Alçıpan Yayı (4 adet) (60x60 için)	1	3,70\$
325628	Isoled Alçıpan Yayı (2 adet) (30x30 için)	1	1,85\$

Özellikler	Koli Adedi	Fiyat
DALI Dim	1	31,25\$



Ekonomik Çözüm

Dealed!



Isoled 60x60

Sıva Altı

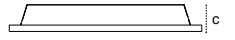

Kod	Güç (W)	Renk Sıcaklığı (K)	Işık Akısı (lm)	Etkinlik Faktörü (lm/W)	Boyutlar (mm)axbxc	Kesim Ölçüsü (mm)	Koli Ağırlığı (kg)	Koli Adedi	Fiyat
111474	36	4000	3816	106	595x595x45	570x570	22,5	6	36,25\$
111475	36	6500	3816	106	595x595x45	570x570	22,5	6	36,25\$

Özellikler	Metal	Opal Difüzör	3000/4000/6500K	IP40	50.000h	5 Yıl
Opsiyonlar	DALI	1-10V	Acil Aydınlatma (1-3 saat)	Clip-in	Alçıpan	



Isoled 30x30

Sıva Altı

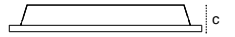

Kod	Güç (W)	Renk Sıcaklığı (K)	Işık Akısı (lm)	Etkinlik Faktörü (lm/W)	Boyutlar (mm)axbxc	Kesim Ölçüsü (mm)	Koli Ağırlığı (kg)	Koli Adedi	Fiyat
115346	12	4000	1200	100	295x295x45	270x270	7	5	18,00\$
115347	12	6500	1200	100	295x295x45	270x270	7	5	18,00\$

Özellikler	Metal	Opal Difüzör	3000/4000/6500K	IP40	50.000h	5 Yıl
Opsiyonlar	DALI	1-10V	Acil Aydınlatma (1-3 saat)	Clip-in	Alçıpan	



Isoled 30x60

Sıva Altı

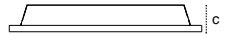

Kod	Güç (W)	Renk Sıcaklığı (K)	Işık Akısı (lm)	Etkinlik Faktörü (lm/W)	Boyutlar (mm)axbxc	Kesim Ölçüsü (mm)	Koli Ağırlığı (kg)	Koli Adedi	Fiyat
111821	17	4000	1751	103	595x295x45	270x570	11,4	6	28,50\$
111822	17	6500	1751	103	595x295x45	270x570	11,4	6	28,50\$

Özellikler	Metal	Opal Difüzör	3000/4000/6500K	IP40	50.000h	5 Yıl
Opsiyonlar	DALI	1-10V	Acil Aydınlatma (1-3 saat)	Clip-in	Alçıpan	



Isoled 30x120

Sıva Altı

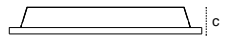

Kod	Güç (W)	Renk Sıcaklığı (K)	Işık Akısı (lm)	Etkinlik Faktörü (lm/W)	Boyutlar (mm)axbxc	Kesim Ölçüsü (mm)	Koli Ağırlığı (kg)	Koli Adedi	Fiyat
113008	36	4000	3888	108	1195x295x45	270x1170	12,8	4	47,25\$
113009	36	6500	3888	108	1195x295x45	270x1170	12,8	4	47,25\$

Özellikler	Metal	Opal Difüzör	3000/4000/6500K	IP40	50.000h	5 Yıl
Opsiyonlar	DALI	1-10V	Acil Aydınlatma (1-3 saat)	Clip-in	Alçıpan	



Dealed 60x60

Sıva Altı

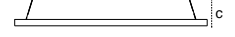

Kod	Güç (W)	Renk Sıcaklığı (K)	Işık Akısı (lm)	Etkinlik Faktörü (lm/W)	Boyutlar (mm)axbxc	Kesim Ölçüsü (mm)	Koli Ağırlığı (kg)	Koli Adedi	Fiyat
116173	36	4000	3708	103	595x595x33	570x570	15	10	25,25\$
116174	36	6500	3708	103	595x595x33	570x570	15	10	25,25\$

Özellikler	Metal	Opal Difüzör	3000/4000/6500K	IP40	50.000h
Opsiyonlar	Acil Aydınlatma (1-3 saat)	Clip-in	Alçıpan		



Fertis

Sıva Altı

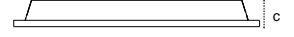

Kod	Tip	Güç (W)	Renk Sıcaklığı (K)	Işık Akısı (lm)	Etkinlik Faktörü (lm/W)	Boyutlar (mm)axbxc	Kesim Ölçüsü (mm)	Koli Ağırlığı (kg)	Koli Adedi	Fiyat
115460	CRI80	36	4000	5220	145	595x595x33	570x570	15,1	10	48,00\$
115457	CRI80+UGR<19	36	4000	4860	135	595x595x33	570x570	15,1	10	52,00\$

- Özellikler**
- Metal
 - Opal Difüzör
 - 3000/4000/6500K
 - IP40
 - 50.000h
- Opsiyonlar**
- DALI
 - 1-10V
 - Acil Aydınlatma (1-3 saat)
 - Clip-in
 - Alçıpan



Divaled Endirekt

Sıva Altı / Sıva Üstü

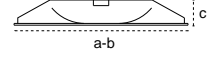

Kod	Tip	Güç (W)	Renk Sıcaklığı (K)	Işık Akısı (lm)	Etkinlik Faktörü (lm/W)	Boyutlar (mm)axbxc	Kesim Ölçüsü (mm)	Koli Ağırlığı (kg)	Koli Adedi	Fiyat
108125	Sıva Altı	42	4000	2940	70	595x595x72	580x580	16,36	4	76,50 \$
108408	Sıva Altı	42	6500	2940	70	595x595x72	580x580	16,36	4	76,50 \$
110601	Sıva Üstü	42	4000	2940	70	595x595x72	-	16,36	4	92,50 \$
110602	Sıva Üstü	42	6500	2940	70	595x595x72	-	16,36	4	92,50 \$

- Özellikler**
- Metal
 - Opal Difüzör
 - 3000/4000/6500K
 - IP20
 - 50.000h
- Opsiyonlar**
- DALI
 - 1-10V
 - Acil Aydınlatma (1-3 saat)
 - Clip-in
 - Alçıpan
 - Sıva Üstü



Cleaed IP65

Sıva Altı

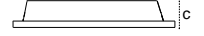

Kod	Güç (W)	Renk Sıcaklığı (K)	Işık Akısı (lm)	Etkinlik Faktörü (lm/W)	Boyutlar (mm)axbxc	Kesim Ölçüsü (mm)	Koli Ağırlığı (kg)	Koli Adedi	Fiyat
113695	12	4000	1416	118	295x295x61	280x280	7	5	34,50\$
113696	12	6500	1416	118	295x295x61	280x280	7	5	34,50\$
113277	36	4000	3708	103	595x595x45	580x580	18	6	65,00\$
113278	36	6500	3708	103	595x595x45	580x580	18	6	65,00\$

- Özellikler**
- Metal
 - Opal Difüzör
 - 3000/4000/6500K
 - IP65
 - 50.000h
- Opsiyonlar**
- DALI
 - 1-10V
 - Acil Aydınlatma (1-3 saat)
 - Clip-in
 - Alçıpan



IP65 Steril

Sıva Altı Temperli Camlı



Kod	Güç (W)	Renk Sıcaklığı (K)	Işık Akısı (lm)	Etkinlik Faktörü (lm/W)	Boyutlar (mm)axbxc	Kesim Ölçüsü (mm)	Koli Ağırlığı (kg)	Koli Adedi	Fiyat
109776	36	4000	3240	90	595x595x92	580x580	-	2	105,00\$
109777	36	6500	3240	90	595x595x92	580x580	-	2	105,00\$

- Özellikler**
- Metal
 - Temperli Cam
 - 3000/4000/6500K
 - IP65
 - 50.000h
- Opsiyonlar**
- DALI
 - 1-10V
 - Acil Aydınlatma (1-3 saat)
 - Alçıpan
 - Sıva Üstü



Endirekt Steril 60x60

Sıva Altı

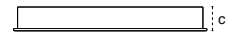

Kod	Güç (W)	Renk Sıcaklığı (K)	Işık Akısı (lm)	Etkinlik Faktörü (lm/W)	Boyutlar (mm)axbxc	Kesim Ölçüsü (mm)	Koli Ağırlığı (kg)	Koli Adedi	Fiyat
113439	42	4000	3150	75	595x595x92	580x580	13	1	144,00\$
113440	42	6500	3150	75	595x595x92	580x580	13	1	144,00\$

- Özellikler**
- Metal
 - Opal Difüzör
 - 3000/4000/6500K
 - IP65
 - 50.000h
- Opsiyonlar**
- DALI
 - 1-10V
 - Acil Aydınlatma (1-3 saat)
 - Alçıpan





Isoled 30x30



Kod	Güç (W)	Renk Sıcaklığı (K)	Işık Akısı (lm)	Etkinlik Faktörü (lm/W)	Boyutlar (mm)axbxc	Koli Ağırlığı (kg)	Koli Adedi	Fiyat
111582	12	4000	1200	100	300x300x55	7	5	24,30\$
111583	12	6500	1200	100	300x300x55	7	5	24,30\$

Özellikler	 Metal	 Opal Difüzör	 3000/4000/6500K	 IP40	 50.000h	 5 Yıl
Opsiyonlar	 DALI	 1-10V	 Acil Aydınlatma (1-3 saat)	 Clip-in	 Alçıpan	



Isoled 60x60

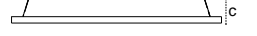

Kod	Güç (W)	Renk Sıcaklığı (K)	Işık Akısı (lm)	Etkinlik Faktörü (lm/W)	Boyutlar (mm)axbxc	Koli Ağırlığı (kg)	Koli Adedi	Fiyat
111480	36	4000	3708	103	600x600x55	22,5	6	39,55\$
111481	36	6500	3708	103	600x600x55	22,5	6	39,55\$

Özellikler	 Metal	 Opal Difüzör	 3000/4000/6500K	 IP40	 50.000h	 5 Yıl
Opsiyonlar	 DALI	 1-10V	 Acil Aydınlatma (1-3 saat)	 Clip-in	 Alçıpan	



Cleared 30x30

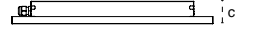

Kod	Güç (W)	Renk Sıcaklığı (K)	Işık Akısı (lm)	Etkinlik Faktörü (lm/W)	Boyutlar (mm)axbxc	Koli Ağırlığı (kg)	Koli Adedi	Fiyat
113657	12	4000	1416	118	300x300x50	7	5	37,80\$
113658	12	6500	1416	118	300x300x50	7	5	37,80\$

Özellikler	 Metal	 Opal Difüzör	 3000/4000/6500K	 IP65	 50.000h	 5 Yıl
Opsiyonlar	 DALI	 1-10V	 Acil Aydınlatma (1-3 saat)	 Clip-in	 Alçıpan	



Cleared 60x60

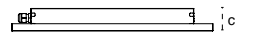

Kod	Güç (W)	Renk Sıcaklığı (K)	Işık Akısı (lm)	Etkinlik Faktörü (lm/W)	Boyutlar (mm)axbxc	Koli Ağırlığı (kg)	Koli Adedi	Fiyat
113261	36	4000	4464	124	600x600x50	15	5	68,30\$
111622	36	6500	4464	124	600x600x50	15	5	68,30\$

Özellikler	 Metal	 Opal Difüzör	 3000/4000/6500K	 IP65	 50.000h	 5 Yıl
Opsiyonlar	 DALI	 1-10V	 Acil Aydınlatma (1-3 saat)	 Clip-in	 Alçıpan	

Dekoled G3T

Profesyonel Çözüm Dekoled!



Avrupa Menşei ENEC Belgeli Sürücü



113 lm/W'a Varan Verimlilik



50.000 Saat Ömür



Tarak PCB



PF>0,95



PMMA Difüzör



61mm Kasa Kalınlığı



Dekoled 60x60

Sıva Üstü

Kod	Güç (W)	Renk Sıcaklığı (K)	Işık Akısı (lm)	Etkinlik Faktörü (lm/W)	Boyutlar (mm)axbxc	Koli Ağırlığı (kg)	Koli Adedi	Fiyat
111439	36	4000	4068	113	600x600x61	25,6	6	51,25\$
111440	36	6500	4068	113	600x600x61	25,6	6	51,25\$

Özellikler: Metal, Opal Difüzör, 3000/4000/6500K, IP40, 50.000h, 5 Yıl

Opsiyonlar: DALI, 1-10V, Acil Aydınlatma (1-3 saat)



Dekoled 30x30

Sıva Üstü

Kod	Güç (W)	Renk Sıcaklığı (K)	Işık Akısı (lm)	Etkinlik Faktörü (lm/W)	Boyutlar (mm)axbxc	Koli Ağırlığı (kg)	Koli Adedi	Fiyat
111357	12	4000	1236	103	308x308x51	6,2	5	26,50\$
111358	12	6500	1236	103	308x308x51	6,2	5	26,50\$

Özellikler: Metal, Opal Difüzör, 3000/4000/6500K, IP40, 50.000h, 5 Yıl

Opsiyonlar: DALI, 1-10V, Acil Aydınlatma (1-3 saat)



Dekoled 30x60

Sıva Üstü

Kod	Güç (W)	Renk Sıcaklığı (K)	Işık Akısı (lm)	Etkinlik Faktörü (lm/W)	Boyutlar (mm)axbxc	Koli Ağırlığı (kg)	Koli Adedi	Fiyat
111455	17	4000	1785	105	308x600x61	11	5	43,25\$
111456	17	6500	1785	105	308x600x61	11	5	43,25\$

Özellikler: Metal, Opal Difüzör, 3000/4000/6500K, IP40, 50.000h, 5 Yıl

Opsiyonlar: DALI, 1-10V, Acil Aydınlatma (1-3 saat)



Dekoled 30x120

Sıva Üstü

Kod	Güç (W)	Renk Sıcaklığı (K)	Işık Akısı (lm)	Etkinlik Faktörü (lm/W)	Boyutlar (mm)axbxc	Koli Ağırlığı (kg)	Koli Adedi	Fiyat
111458	36	4000	3960	110	308x1200x61	20,5	4	68,25\$
111459	36	6500	3960	110	308x1200x61	20,5	4	68,25\$

Özellikler: Metal, Opal Difüzör, 3000/4000/6500K, IP40, 50.000h, 5 Yıl

Opsiyonlar: DALI, 1-10V, Acil Aydınlatma (1-3 saat)



Dekoled 60x120

Sıva Üstü

Kod	Güç (W)	Renk Sıcaklığı (K)	Işık Akısı (lm)	Etkinlik Faktörü (lm/W)	Boyutlar (mm)axbxc	Koli Ağırlığı (kg)	Koli Adedi	Fiyat
113392	72	4000	7200	100	600x1200x61	4,8	1	129,00\$
113393	72	6500	7200	100	600x1200x61	4,8	1	129,00\$

Özellikler: Metal, Opal Difüzör, 3000/4000/6500K, IP40, 50.000h, 5 Yıl

Opsiyonlar: DALI, 1-10V, Acil Aydınlatma (1-3 saat)



Ekonomik Çözüm

Dealed!

2
YIL
GARANTİ

ENEC Belgesi
Sürücü

TSE
Belgesi



Lensli
Modül

TSE

Dekoled 60x60

Sıva Üstü

Kod	Güç (W)	Renk Sıcaklığı (K)	Işık Akısı (lm)	Etkinlik Faktörü (lm/W)	Boyutlar (mm)axbxc	Koli Ağırlığı (kg)	Koli Adedi	Fiyat
111499	36	4000	3708	103	600x600x61	24,6	6	43,75\$
111500	36	6500	3708	103	600x600x61	24,6	6	43,75\$

Özellikler: Metal, Opal Difüzör, 3000/4000/6500K, IP40, 50.000h, 5 Yıl

Opsiyonlar: DALI, 1-10V, Acil Aydınlatma (1-3 saat)



Lensli
Modül

TSE

Dekoled 30x30

Sıva Üstü

Kod	Güç (W)	Renk Sıcaklığı (K)	Işık Akısı (lm)	Etkinlik Faktörü (lm/W)	Boyutlar (mm)axbxc	Koli Ağırlığı (kg)	Koli Adedi	Fiyat
115827	12	4000	1200	100	308x308x51	6,2	5	21,50\$
116110	12	6500	1200	100	308x308x51	6,2	5	21,50\$

Özellikler: Metal, Opal Difüzör, 3000/4000/6500K, IP40, 50.000h, 5 Yıl

Opsiyonlar: DALI, 1-10V, Acil Aydınlatma (1-3 saat)



Lensli
Modül

TSE

Dekoled 30x60

Sıva Üstü

Kod	Güç (W)	Renk Sıcaklığı (K)	Işık Akısı (lm)	Etkinlik Faktörü (lm/W)	Boyutlar (mm)axbxc	Koli Ağırlığı (kg)	Koli Adedi	Fiyat
111839	17	4000	1700	100	308x600x61	10,3	5	35,00\$
111840	17	6500	1700	100	308x600x61	10,3	5	35,00\$

Özellikler: Metal, Opal Difüzör, 3000/4000/6500K, IP40, 50.000h, 5 Yıl

Opsiyonlar: DALI, 1-10V, Acil Aydınlatma (1-3 saat)



Lensli
Modül

TSE

Dekoled 30x120

Sıva Üstü

Kod	Güç (W)	Renk Sıcaklığı (K)	Işık Akısı (lm)	Etkinlik Faktörü (lm/W)	Boyutlar (mm)axbxc	Koli Ağırlığı (kg)	Koli Adedi	Fiyat
113041	36	4000	3708	103	308x1200x61	20,5	4	56,50\$
113042	36	6500	3708	103	308x1200x61	20,5	4	56,50\$

Özellikler: Metal, Opal Difüzör, 3000/4000/6500K, IP40, 50.000h, 5 Yıl

Opsiyonlar: DALI, 1-10V, Acil Aydınlatma (1-3 saat)



Lensli
Modül

TSE

Dealed 60x60

Sıva Üstü

Kod	Güç (W)	Renk Sıcaklığı (K)	Işık Akısı (lm)	Etkinlik Faktörü (lm/W)	Boyutlar (mm)axbxc	Koli Ağırlığı (kg)	Koli Adedi	Fiyat
116175	36	4000	3708	103	595x595x45	15	6	34,20\$
116176	36	6500	3708	103	595x595x45	15	6	34,20\$

Özellikler: Metal, Opal Difüzör, 3000/4000/6500K, IP40, 50.000h

Opsiyonlar: Acil Aydınlatma (1-3 saat)

Linna

Sıva Üstü

Sıva Altı

Sonsuz Lineer Bağlantı

Bağlantı aparatları ile ürüne müdahale edilmeksizin dışardan kesintisiz lineer bağlantı yapılır.

RAL 9005

RAL 9006

RAL 9016

- LED Çip (LM80-TM218) • ENEC Belgeli Sürücü • Acil Aydınlatma • DALI Opsiyonu

Linna

Sıva Üstü



Kod	Güç (W)	Renk Sıcaklığı (K)	Işık Akısı (lm)	Etkinlik Faktörü (lm/W)	Boyutlar (mm)axbxc	Koli Ağırlığı (kg)	Koli Adedi	Fiyat
209137	20	4000	2000	100	50x70x500	19,2	24	30,60\$
209139	36	4000	3600	100	50x70x1000	19,1	12	61,20\$
209140	56	4000	5600	100	50x70x1500	27	12	91,80\$

Özellikler	Alüminyum	Opal Difüzör	3000/4000/6500K	IP40	50.000h
Opsiyonlar	DALI	1-10V	Acil Aydınlatma (1+3 saat)	Through Wiring	RAL 9016

Linna T-X-L Bağlantı Armatürleri

Sıva Üstü



Kod	Tip	Güç (W)	Renk Sıcaklığı (K)	Işık Akısı (lm)	Etkinlik Faktörü (lm/W)	Boyutlar (mm)axbxc	Koli Ağırlığı (kg)	Koli Adedi	Fiyat
209739	L	20	4000	2000	100	270x70x290	0,598	1	35,60\$
209736	T	20	4000	2000	100	250x70x300	0,595	1	38,60\$
209742	X	20	4000	2000	100	250x70x300	0,77	1	45,60\$

Özellikler	Alüminyum	Opal Difüzör	3000/4000/6500K	IP40	50.000h	Through Wiring
Opsiyonlar	DALI	1-10V	RAL 9016			

Kod	Özellikler	Koli Adedi	Fiyat
304906	Askı Aparatı 100 cm (2 adet)	1	4,60 \$
304915	Askı Aparatı 150 cm (2 adet)	1	5,60 \$
317986	Askı Ronans Takımı 150 cm Siyah (2 Adet)	1	5,60 \$
209870	Lineer Birleştirme Aparatı Takımı (2 Adet)	1	2,35 \$



Yeni Ürün



Trenta

Sıva Üstü

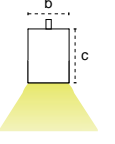

Kod	Güç (W)	Renk Sıcaklığı (K)	Işık Akısı (lm)	Etkinlik Faktörü (lm/W)	Boyutlar (mm)axbxc	Koli Ağırlığı (kg)	Koli Adedi	Fiyat
210236	14	4000	1400	100	500x33x58	0,6	1	32,25\$
210239	28	4000	2800	100	1000x33x58	1,1	1	57,75\$
110851	26	4000	2600	100	1200x33x58	1,4	1	69,30\$
210242	42	4000	4200	100	1500x33x58	1,6	1	96,50\$

Özellikler	Alüminyum	Opal Difüzör	3000/4000/6500K	IP40	50.000h
Opsiyonlar	DALI	1-10V	Acil Aydınlatma (1-3 saat)		



Eterna Endirekt (47mm)

Sıva Üstü

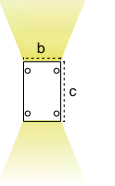

Kod	Güç (W)	Renk Sıcaklığı (K)	Işık Akısı (lm)	Etkinlik Faktörü (lm/W)	Boyutlar (mm)axbxc	Koli Ağırlığı (kg)	Koli Adedi	Fiyat
206015	26-16	4000	2600-1440	100-90	900x47x85	-	1	124,00\$
206016	34-18	4000	3400-1620	100-90	1200x47x85	-	1	137,00\$
206017	44-24	4000	4400-2160	100-90	1470x47x85	-	1	163,00\$
206018	60-40	4000	6000-3600	100-90	2000x47x85	-	1	229,00\$

Özellikler	Alüminyum	Opal Difüzör	3000/4000/6500K	IP40	50.000h
Opsiyonlar	DALI	1-10V	Acil Aydınlatma (1-3 saat)	RAL 9016	



Linna

Sıva Altı

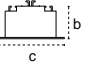

Kod	Güç (W)	Renk Sıcaklığı (K)	Işık Akısı (lm)	Etkinlik Faktörü (lm/W)	Boyutlar (mm)axbxc	Kesim Ölçüsü (mm)	Koli Ağırlığı (kg)	Koli Adedi	Fiyat
212267	14	4000	1260	90	540x77x85	520x62	1,15	1	44,40\$
212268	20	4000	1800	90	1040x77x85	1020x62	1,47	1	58,70\$
212269	28	4000	2520	90	1240x77x85	1220x62	1,77	1	71,40\$
212270	42	4000	3780	90	1520x77x85	1500x62	2,15	1	95,50\$

Özellikler	Alüminyum	Opal Difüzör	3000/4000/6500K	IP40	50.000h
Opsiyonlar	DALI	1-10V	RAL 9016		

Kod	Özellikler	Koli Adedi	Fiyat
304906	Askı Aparatı 100 cm (2 adet)	1	4,60 \$
304915	Askı Aparatı 150 cm (2 adet)	1	5,60 \$
317986	Askı Ronans Takımı 150 cm Siyah (2 Adet)	1	5,60 \$
209870	Lineer Birleştirme Aparatı Takımı (2 Adet)	1	2,35 \$



Her Mekana Uygun Bir Tira Downlight Mutlaka Vardır!



3 Farklı Boy



Tira S
Sıva Altı

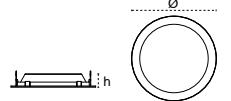

Kod	Güç (W)	Renk Sıcaklığı (K)	Işık Akısı (lm)	Etkinlik Faktörü (lm/W)	Boyutlar (mm)Øxh	Kesim Ölçüsü (mm)	Koli Ağırlığı (kg)	Koli Adedi	Fiyat
210164	10	4000	1000	100	110x41	100	12,6	60	31,25\$
210168	15	4000	1860	124	175x41	165	12,4	24	35,75\$
210170	20	4000	2440	122	175x41	165	12,4	24	41,00\$
210172	20	4000	2460	123	225x41	215	13,3	24	49,75\$
210174	30	4000	3660	122	225x41	215	13,3	18	59,25\$
210176	35	4000	4235	121	225x41	215	13,3	18	69,25\$

- Özellikler** Alüminyum Opal Difüzör 3000/4000/6500K IP40 50.000h 5 Yıl
- Opsiyonlar** DALI 1-10V Acil Aydınlatma (1-3 saat) RAL 9005

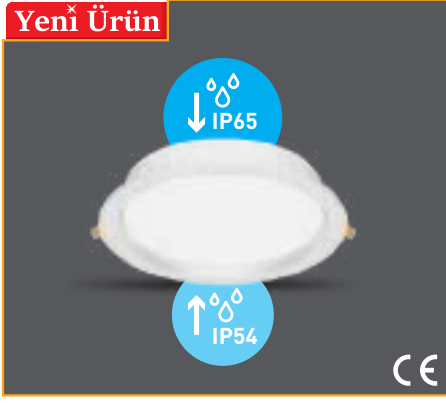

Tira S IP54/IP65
Sıva Altı

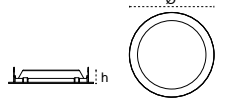

Kod	Güç (W)	Renk Sıcaklığı (K)	Işık Akısı (lm)	Etkinlik Faktörü (lm/W)	Boyutlar (mm)Øxh	Kesim Ölçüsü (mm)	Koli Ağırlığı (kg)	Koli Adedi	Fiyat
210185	10	4000	1000	100	110x41	100	12,6	24	41,25\$
210189	15	4000	1860	124	175x41	165	12,4	24	45,75\$
210191	20	4000	2440	122	175x41	165	12,4	24	51,00\$
210199	20	4000	2460	123	225x41	215	13,3	24	59,75\$
210392	30	4000	3660	122	225x41	215	13,3	18	69,25\$
210203	35	4000	4235	121	225x41	215	13,3	18	79,25\$

- Özellikler** Alüminyum Opal Difüzör 3000/4000/6500K IP54 / IP65 50.000h 5 Yıl
- Opsiyonlar** DALI 1-10V Acil Aydınlatma (1-3 saat) RAL 9005



Tira S
Sıva Üstü

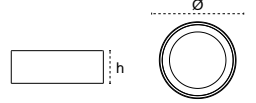

Kod	Güç (W)	Renk Sıcaklığı (K)	Işık Akısı (lm)	Etkinlik Faktörü (lm/W)	Boyutlar (mm)Øxh	Koli Ağırlığı (kg)	Koli Adedi	Fiyat
210673	10	4000	1000	100	110x66	-	24	36,75\$
210677	15	4000	1860	124	157x66	-	16	41,75\$
210683	20	4000	2440	122	157x66	-	16	47,00\$
210685	20	4000	2460	123	209x68	-	12	56,75\$
210687	30	4000	3660	122	209x68	-	12	66,25\$
210689	35	4000	4235	121	209x68	-	12	76,25\$

- Özellikler** Alüminyum Opal Difüzör 3000/4000/6500K IP40 50.000h 5 Yıl
- Opsiyonlar** DALI 1-10V Acil Aydınlatma (1-3 saat) RAL 9005

Kod	Özellikler	Koli Adedi	Fiyat
327764	Downlight Acil Aydınlatma Kit Opsiyonu (1saat)	1	27,60 \$
327251	Downlight Acil Aydınlatma Kit Opsiyonu (3saat)	1	31,60 \$





TSE Belgeli

ENEC Belgeli
SürücüTek Ölçüde
3 Farklı GüçIP54 / IP65
SeçeneğiSıva Üstü
Opsiyonu

Rita G2

Sıva Altı

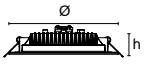

Kod	Güç (W)	Renk Sıcaklığı (K)	Işık Akısı (lm)	Etkinlik Faktörü (lm/W)	Boyutlar (mm)Øxh	Kesim Ölçüsü (mm)	Koli Ağırlığı (kg)	Koli Adedi	Fiyat
116197	10	4000	1240	124	145x30	120	9	30	21,25\$
116480	14	4000	1736	124	145x30	120	9	30	23,00\$
116200	20	4000	2240	112	145x30	120	9	30	25,00\$

Özellikler	Alüminyum	Opal Difüzör	3000/4000/6500K	IP40	50.000h	2 Yıl
Opsiyonlar	DALI	1-10V	Acil Aydınlatma (1-3 saat)			

Yeni Ürün

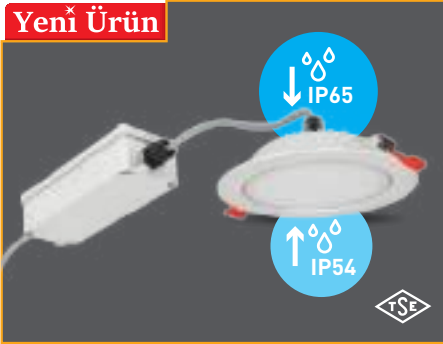

Rita G2 IP54/IP65

Sıva Altı

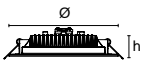

Kod	Güç (W)	Renk Sıcaklığı (K)	Işık Akısı (lm)	Etkinlik Faktörü (lm/W)	Boyutlar (mm)Øxh	Kesim Ölçüsü (mm)	Koli Ağırlığı (kg)	Koli Adedi	Fiyat
116624	10	4000	1100	110	145x35	120	10	20	34,50\$
116625	14	4000	1540	110	145x35	120	10	20	36,50\$
116626	20	4000	2200	110	145x35	120	10	20	39,00\$

Özellikler	Alüminyum	Opal Difüzör	3000/4000/6500K	IP45-4	50.000h	2 Yıl
Opsiyonlar	DALI	1-10V	Acil Aydınlatma (1-3 saat)			

Yeni Ürün



Rita G2

Sıva Üstü

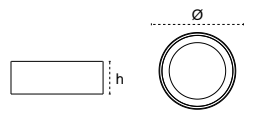

Kod	Güç (W)	Renk Sıcaklığı (K)	Işık Akısı (lm)	Etkinlik Faktörü (lm/W)	Boyutlar (mm)Øxh	Koli Ağırlığı (kg)	Koli Adedi	Fiyat
116254	10	4000	1100	110	150x90	11	20	29,50\$
116524	14	4000	1540	110	150x90	11	20	31,25\$
116251	20	4000	2200	110	150x90	11	20	33,50\$

Özellikler	Alüminyum	Opal Difüzör	3000/4000/6500K	IP40	50.000h	2 Yıl
Opsiyonlar	DALI	Acil Aydınlatma (1-3 saat)				

Kod	Özellikler	Koli Adedi	Fiyat
327764	Downlight Acil Aydınlatma Kit Opsiyonu (1saat)	1	27,60 \$
333852	Downlight Acil Aydınlatma Kit Opsiyonu (3saat) DALI Dim Farkı	1	31,60 \$ 31,25 \$

5
YIL
GARANTİ

Dore

7W

10W-13W

18W-22W



TSE Belgesi



Slim
Tasarım



134 lm/W'a
Varan Verimlilik



ENEC Belgesi
Sürücü



+50.000h
LED Ömrü



Dore 7W

Sıva Altı

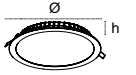

Kod	Güç (W)	Renk Sıcaklığı (K)	Işık Akısı (lm)	Etkinlik Faktörü (lm/W)	Boyutlar (mm)Øxh	Kesim Ölçüsü (mm)	Koli Ağırlığı (kg)	Koli Adedi	Fiyat
110864	7	4000	791	113	120x45	105	6	30	13,25\$

Özellikler	Opsiyonlar
<ul style="list-style-type: none"> ABS-PC Opal Difüzör 3000/4000/6500K IP40 50.000h 5 Yıl 	<ul style="list-style-type: none"> DALI 1-10V Acil Aydınlatma (1-3 saat)



Dore 10W/13W

Sıva Altı

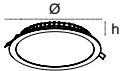

Kod	Güç (W)	Renk Sıcaklığı (K)	Işık Akısı (lm)	Etkinlik Faktörü (lm/W)	Boyutlar (mm)Øxh	Kesim Ölçüsü (mm)	Koli Ağırlığı (kg)	Koli Adedi	Fiyat
110865	10	4000	1120	112	170x45	155	10	30	16,60\$
110866	13	4000	1547	119	170x45	155	10	30	18,95\$

Özellikler	Opsiyonlar
<ul style="list-style-type: none"> ABS-PC Opal Difüzör 3000/4000/6500K IP40 50.000h 5 Yıl 	<ul style="list-style-type: none"> DALI 1-10V Acil Aydınlatma (1-3 saat)



Dore 18W/22W

Sıva Altı

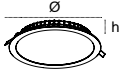

Kod	Güç (W)	Renk Sıcaklığı (K)	Işık Akısı (lm)	Etkinlik Faktörü (lm/W)	Boyutlar (mm)Øxh	Kesim Ölçüsü (mm)	Koli Ağırlığı (kg)	Koli Adedi	Fiyat
110867	18	4000	2412	134	225x45	205	11,4	20	24,90\$
110868	22	4000	2948	134	225x45	205	11,4	20	26,15\$

Özellikler	Opsiyonlar
<ul style="list-style-type: none"> ABS-PC Opal Difüzör 3000/4000/6500K IP40 50.000h 5 Yıl 	<ul style="list-style-type: none"> DALI 1-10V Acil Aydınlatma (1-3 saat)



Dore 18W/22W

Sıva Üstü

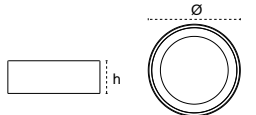

Kod	Güç (W)	Renk Sıcaklığı (K)	Işık Akısı (lm)	Etkinlik Faktörü (lm/W)	Boyutlar (mm)Øxh	Koli Ağırlığı (kg)	Koli Adedi	Fiyat
111752	18	4000	2412	134	228x55	7,2	10	29,65\$
111755	22	4000	2420	110	228x55	7,2	10	31,70\$

Özellikler	Opsiyonlar
<ul style="list-style-type: none"> ABS-PC Opal Difüzör 3000/4000/6500K IP40 50.000h 5 Yıl 	<ul style="list-style-type: none"> DALI 1-10V Acil Aydınlatma (1-3 saat)

Kod	Özellikler	Koli Adedi	Fiyat
327764	Acil Aydınlatma Kiti (1 saat)	1	27,60\$
333852	Acil Aydınlatma Kiti (3 saat)	1	31,60\$



x2.09 kat
daha fazla ışık çıktısı

Sirma

Birebir
Değişim Garantisi



*Sirma backlight, sıradan slim downlight armatürlere göre 2,09 kat daha fazla ışık çıktısı sunar.



Slim
Tasarım



Backlight
Işık Konforu



Dahili
Sürücü



Acil Kit
Uygulaması



Sirma 6W/9W

Sıva Altı

Kod	Güç (W)	Renk Sıcaklığı (K)	Işık Akısı (lm)	Etkinlik Faktörü (lm/W)	Boyutlar (mm)Øxh	Kesim Ölçüsü (mm)	Koli Ağırlığı (kg)	Koli Adedi	Fiyat
110330	6	3000	528	88	120x45	105	2,5	20	5,00\$
110331	6	4000	528	88	120x45	105	2,5	20	5,00\$
110332	6	6500	528	88	120x45	105	2,5	20	5,00\$
110333	9	3000	783	87	120x45	105	2,5	20	6,55\$
110334	9	4000	783	87	120x45	105	2,5	20	6,55\$
110335	9	6500	783	87	120x45	105	2,5	20	6,55\$

Özellikler ABS-PC Opal Difüzör 3000/4000/6500K IP40 30.000h

Opsiyonlar Acil Aydınlatma (1-3 saat)

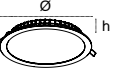

Sirma 12W/15W

Sıva Altı

Kod	Güç (W)	Renk Sıcaklığı (K)	Işık Akısı (lm)	Etkinlik Faktörü (lm/W)	Boyutlar (mm)Øxh	Kesim Ölçüsü (mm)	Koli Ağırlığı (kg)	Koli Adedi	Fiyat
110339	12	3000	1092	91	170x45	155	3,1	15	7,80\$
110340	12	4000	1092	91	170x45	155	3,1	15	7,80\$
110341	12	6500	1092	91	170x45	155	3,1	15	7,80\$
110342	15	3000	1350	90	170x45	155	3,1	15	9,70\$
110343	15	4000	1350	90	170x45	155	3,1	15	9,70\$
110344	15	6500	1350	90	170x45	155	3,1	15	9,70\$

Özellikler ABS-PC Opal Difüzör 3000/4000/6500K IP40 30.000h

Opsiyonlar Acil Aydınlatma (1-3 saat)

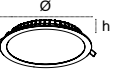

Sirma 18W/24W

Sıva Altı

Kod	Güç (W)	Renk Sıcaklığı (K)	Işık Akısı (lm)	Etkinlik Faktörü (lm/W)	Boyutlar (mm)Øxh	Kesim Ölçüsü (mm)	Koli Ağırlığı (kg)	Koli Adedi	Fiyat
115751	18	3000	1782	99	195x45	175	3,7	10	10,80\$
115752	18	4000	1782	99	195x45	175	3,7	10	10,80\$
115822	18	6500	1782	99	195x45	175	3,7	10	10,80\$
116303	24	4000	2040	85	225x45	205	3,7	10	11,50\$
116304	24	6500	2040	85	225x45	205	3,7	10	11,50\$

Özellikler ABS-PC Opal Difüzör 3000/4000/6500K IP40 30.000h

Opsiyonlar Acil Aydınlatma (1-3 saat)

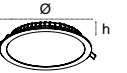

Sirma Sıva Üstü

Kod	Güç (W)	Renk Sıcaklığı (K)	Işık Akısı (lm)	Etkinlik Faktörü (lm/W)	Boyutlar (mm)Øxh	Koli Ağırlığı (kg)	Koli Adedi	Fiyat
116047	24	3000	2376	99	228x55	5,2	10	16,40\$
116048	24	4000	2376	99	228x55	5,2	10	16,40\$
116049	24	6500	2376	99	228x55	5,2	10	16,40\$

Özellikler ABS-PC Opal Difüzör 3000/4000/6500K IP40 30.000h

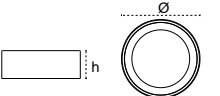

Kod	Özellikler	Koli Adedi	Fiyat
313117	Acil Aydınlatma Kit Opsiyonu (1 saat)	1	27,60\$

Pio



IP40, Metal Gövde

Opal Difüzör

Sensör Opsiyonu



Pio

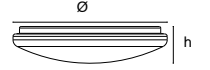

Kod	Güç (W)	Renk Sıcaklığı (K)	Işık Akısı (lm)	Etkinlik Faktörü (lm/W)	Boyutlar (mm)Øxh	Koli Ağırlığı (kg)	Koli Adedi	Fiyat
206688	12	4000	840	70	258x57	5,58	10	6,50\$
206677	12	6500	840	70	258x57	5,58	10	6,50\$
206037	18	4000	1260	70	335x60	7,49	10	8,25\$
206913	18	6500	1260	70	335x60	7,49	10	8,25\$
208411	28	4000	1960	70	387x58	13,8	10	10,00\$
208412	28	6500	1960	70	387x58	13,8	10	10,00\$

Özellikler Metal Opal Difüzör 4000 / 6500K IP40 30.000h
Opsiyonlar Radar Sensör



Pio Radar Sensörlü

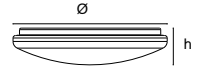

Kod	Güç (W)	Renk Sıcaklığı (K)	Işık Akısı (lm)	Etkinlik Faktörü (lm/W)	Boyutlar (mm)Øxh	Koli Ağırlığı (kg)	Koli Adedi	Fiyat
212186	18	4000	1260	70	335x60	7,49	10	14,50\$
208572	18	6500	1260	70	335x60	7,49	10	14,50\$

Özellikler Metal Opal Difüzör 4000 / 6500K IP40 30.000h Radar Sensör



Sense (2xE27)

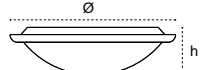

Kod	Tip	Güç (W)	Renk Sıcaklığı (K)	Işık Akısı (lm)	Etkinlik Faktörü (lm/W)	Boyutlar (mm)Øxh	Koli Ağırlığı (kg)	Koli Adedi	Fiyat
110695	2xE27	-	-	-	-	300x105	13	8	7,80\$
110917	2xE27 Sensörlü	-	-	-	-	300x105	13	8	17,10\$
110697	2xE27 Sensörlü+Acil Ayd.	-	-	-	-	300x105	13	8	19,40\$

Özellikler Metal Cam IP20



Sense LED

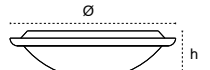

Kod	Tip	Güç (W)	Renk Sıcaklığı (K)	Işık Akısı (lm)	Etkinlik Faktörü (lm/W)	Boyutlar (mm)Øxh	Koli Ağırlığı (kg)	Koli Adedi	Fiyat
110696	Sensörlü	8	6500	864	108	300x105	13	8	16,60\$
104369	Sensörlü + Acil Ayd.	8	6500	864	108	300x105	13	8	27,40\$

Özellikler Metal Cam 6500K IP20 50.000h





Yeni*
Havana



Vidasız Çerçeve ile
Mükemmel Görünüm



Daha Kolay Montaj



Kitli + Radar Sensörlü



IP66 Su ve Toz Almaz!



Sensör

IP66



Havana G2 - E27 Duylu

Kod	Tip	Güç (W)	Renk Sıcaklığı (K)	Işık Akısı (lm)	Etkinlik faktörü (lm/W)	Boyutlar (mm)Øxh	Koli Ağırlığı (kg)	Koli Adedi	Fiyat
111193	1xE27	max.20	-	-	-	260x87	5,8	8	18,70\$
111194	2xE27	max.20	-	-	-	260x87	5,8	8	19,90\$
111220	1xE27+Sensör	max.20	-	-	-	260x87	5,8	8	35,00\$
111223	2xE27+Sensör	max.20	-	-	-	260x87	5,8	8	36,30\$

Özellikler

Polimer Enjeksiyon Opal Difüzör 3000/4000/6500K IP66 50.000h

Opsiyonlar

Radar Sensör RAL 9010

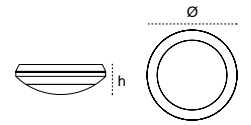

Sensör



Acil

IP66



Havana G2 - LED - ENEC Driver

Kod	Tip	Güç (W)	Renk Sıcaklığı (K)	Işık Akısı (lm)	Etkinlik faktörü (lm/W)	Boyutlar (mm)Øxh	Koli Ağırlığı (kg)	Koli Adedi	Fiyat
116550	LED	18	6500	1980	110	260x87	5,8	8	34,00\$
116551	LED + Sensör	18	6500	1980	110	260x87	5,8	8	50,60\$
116552	LED + Acil Ayd. Kitli	18	6500	1980	110	260x87	5,8	8	61,60\$
116553	LED + Acil Ayd. Kitli + Sensör	18	6500	1980	110	260x87	5,8	8	78,85\$

Özellikler

Polimer Enjeksiyon Opal Difüzör 3000/4000/6500K IP66 50.000h

Opsiyonlar

DALI Acil Aydınlatma (1-3 saat) Radar Sensör

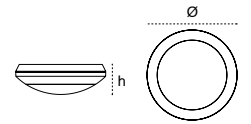

Sensör

IP66



Havana G2 - LED - Integrated Driver

Kod	Tip	Güç (W)	Renk Sıcaklığı (K)	Işık Akısı (lm)	Etkinlik faktörü (lm/W)	Boyutlar (mm)Øxh	Koli Ağırlığı (kg)	Koli Adedi	Fiyat
111692	Integrated Driver	18	6500	1530	85	260x87	5,8	8	27,05\$
111701	Integrated Driver + Sensör	18	6500	1530	85	260x87	5,8	8	43,60\$

Özellikler

Polimer Enjeksiyon Opal Difüzör 3000/4000/6500K IP66 30.000h

Opsiyonlar

Radar Sensör

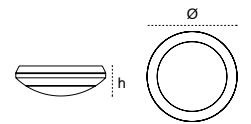



360° Hareket Sensörü

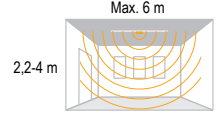

Kod	Algılama Mesafesi (m)	Montaj Yüksekliği (m)	Boyutlar (mm)Øxh	Koli Ağırlığı (kg)	Koli Adedi	Fiyat
314720	Max. 6	2,2-4	80x41	6,2	50	9,95\$

Özellikler Polimer Enjeksiyon IP20 Zaman Ayan Lux Ayan Sun Modu Moon Modu



Varlık Sensörü

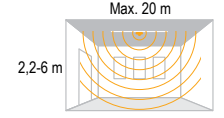

Kod	Algılama Mesafesi (m)	Montaj Yüksekliği (m)	Boyutlar (mm)Øxh	Koli Ağırlığı (kg)	Koli Adedi	Fiyat
314733	Max. 20	2,2-6	102,5x58,3	10	50	25,50\$

Özellikler Polimer Enjeksiyon IP20 Zaman Ayan Lux Ayan Sun Modu Moon Modu



Radar Sensörü

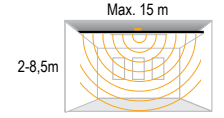

Kod	Tip	Algılama Mesafesi (m)	Montaj Yüksekliği (m)	Boyutlar (mm)axb	Koli Ağırlığı (kg)	Koli Adedi	Fiyat
314735	IP65 Sensör Kutusu	-	-	134x65,5	-	50	11,10\$
314725	Radar Sensör	Max. 15	2-8,5	93x47x44	9,8	100	15,70\$

Özellikler Polimer Enjeksiyon IP20 Zaman Ayan Lux Ayan Hassasiyet Ayan Sun Modu Moon Modu



Sıva Altı Radar Sensörü

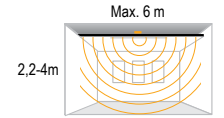

Kod	Algılama Mesafesi (m)	Montaj Yüksekliği (m)	Boyutlar (mm)Øxh	Kesim Ölçüsü (mm)	Koli Ağırlığı (kg)	Koli Adedi	Fiyat
326838	Max. 6	2,2-4	76x74,4	66	7,5	50	15,75\$

Özellikler Polimer Enjeksiyon IP20 Zaman Ayan Lux Ayan Hassasiyet Ayan Sun Modu Moon Modu



Sıva Üstü Radar Sensörü

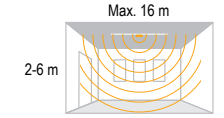

Kod	Algılama Mesafesi (m)	Montaj Yüksekliği (m)	Boyutlar (mm)Øxh	Koli Ağırlığı (kg)	Koli Adedi	Fiyat
326839	Max.16	2-6	114x22	8,06	50	15,75\$

Özellikler Polimer Enjeksiyon IP20 Zaman Ayan Lux Ayan Hassasiyet Ayan Sun Modu Moon Modu



Sıva Altı Tavan Sensörü

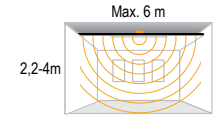

Kod	Algılama Mesafesi (m)	Montaj Yüksekliği (m)	Boyutlar (mm)axbxc	Kesim Ölçüsü (mm)	Koli Ağırlığı (kg)	Koli Adedi	Fiyat
314726	Max. 6	2,2-4	50x66,5x40	65	7	50	11,55\$

Özellikler Polimer Enjeksiyon IP20 Zaman Ayan Lux Ayan Sun Modu Moon Modu



Mini Hareket Sensörü

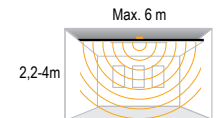

Kod	Algılama Mesafesi (m)	Montaj Yüksekliği (m)	Boyutlar (mm)axbxc	Kesim Ölçüsü (mm)	Koli Ağırlığı (kg)	Koli Adedi	Fiyat
314732	Max. 6	2,2-4	55,4x25,5x36,83	13	-	100	10,20\$

Özellikler Polimer Enjeksiyon IP20 Zaman Ayan Lux Ayan Sun Modu Moon Modu



Yüksek Tavan Sensörü

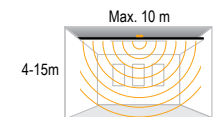

Kod	Algılama Mesafesi (m)	Montaj Yüksekliği (m)	Boyutlar (mm)axbxc	Koli Ağırlığı (kg)	Koli Adedi	Fiyat
314730	Max. 10	4-15	74x32,5x74	6,9	50	35,90\$

Özellikler Polimer Enjeksiyon IP20 Zaman Ayan Lux Ayan Hassasiyet Ayan Sun Modu Moon Modu



Yeni Ürün



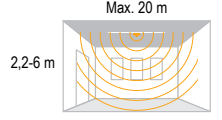

IP65

IP65 Varlık Sensörü



Kod	Algılama Mesafesi (m)	Montaj Yüksekliği (m)	Boyutlar (mm)Øxh	Koli Ağırlığı (kg)	Koli Adedi	Fiyat
333966	Max. 20	2,2-6	59x103	-	50	29,50\$

Özellikler  Polimer Enjeksiyon  IP65  Zaman Ayan  Lux Ayan  Sun Modu

Yeni Ürün



IP54

IP54 Sıva Altı Tavan Sensörü

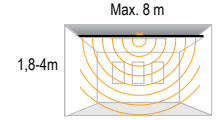

Kod	Algılama Mesafesi (m)	Montaj Yüksekliği (m)	Boyutlar (mm)Øxh	Kesim Ölçüsü (mm)	Koli Ağırlığı (kg)	Koli Adedi	Fiyat
333964	Max. 8	1,8-4	76x49	66	-	50	15,50\$

Özellikler  Polimer Enjeksiyon  IP54  Zaman Ayan  Lux Ayan  Sun Modu

Yeni Ürün



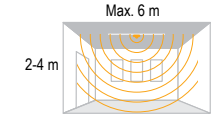

24GHz Ultra Hassas Algılama

360° Varlık Sensörü



Kod	Algılama Mesafesi (m)	Montaj Yüksekliği (m)	Boyutlar (mm)Øxh	Koli Ağırlığı (kg)	Koli Adedi	Fiyat
333967	Max. 6	2-4	114x22	-	50	22,75\$

Özellikler  Polimer Enjeksiyon  IP20  Zaman Ayan  Lux Ayan  Sun Modu

Yeni Ürün



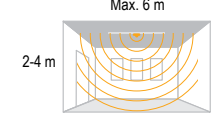

24GHz Ultra Hassas Algılama

IP65 360° Varlık Sensörü



Kod	Algılama Mesafesi (m)	Montaj Yüksekliği (m)	Boyutlar (mm)Øxh	Kesim Ölçüsü (mm)	Koli Ağırlığı (kg)	Koli Adedi	Fiyat
333963	Max. 6	2-4	76x63	66	-	50	34,50\$

Özellikler  Polimer Enjeksiyon  IP65  Zaman Ayan  Lux Ayan  Sun Modu

Yeni Ürün



Koridor Sensörü

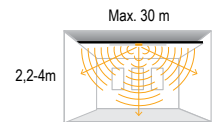

Kod	Algılama Mesafesi (m)	Montaj Yüksekliği (m)	Boyutlar (mm)Øxh	Koli Ağırlığı (kg)	Koli Adedi	Fiyat
333965	Max. 30	2,2-4	53x103	-	50	34,90\$



Özellikler  Polimer Enjeksiyon  IP20  Zaman Ayan  Lux Ayan  Sun Modu

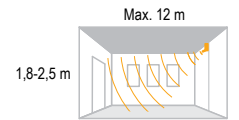

180° Hareket Sensörü



Kod	Algılama Mesafesi (m)	Montaj Yüksekliği (m)	Boyutlar (mm)axbxc	Koli Ağırlığı (kg)	Koli Adedi	Fiyat
314717	Max. 12	1,8-2,5	135x120x66	12,5	50	9,50\$

Özellikler  Polimer Enjeksiyon  IP44  Zaman Ayan  Lux Ayan  Sun Modu  Moon Modu





Fotosel

Gece gündüz farkını algılayarak dış mekan aydınlatmalarında kontrol sağlar.



Kod	Algılama Mesafesi (m)	Montaj Yüksekliği (m)	Boyutlar (mm)axbxc	Koli Ağırlığı (kg)	Koli Adedi	Fiyat
314738	-	-	63x77	13,6	100	6,15\$

Özellikler  Polimer Enjeksiyon  IP44

Acil Aydınlatma ve Yönlendirme Armatürleri



YENİ 1x10W
Metal Emergency Spot

YENİ 2x10W
IP65 Emergency Spot

YENİ Acil Yönlendirme Armatürü
RutaLed



Yeni Ürün



CE

IP65 Emergency Spot

Lumera



Kod	Güç (W)	Batarya	Şarj Süresi	Deşarj Süresi	Işık Akısı (lm)	Renk Sıcaklığı (K)	Etkinlik Faktörü (lm/W)	Boyutlar (mm)axbxc	Koli Ağırlığı (kg)	Koli Adedi	Fiyat
117138	2x10	6V 4500mAh	30h	6h	900	4000	90	350x245x117	11,3	8	140,00\$

Özellikler     



2x10W

CE

IP65 Metal Emergency Spot

Emera

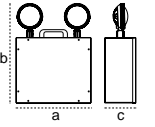

Kod	Güç (W)	Batarya	Şarj Süresi	Deşarj Süresi	Renk Sıcaklığı (K)	Boyutlar (mm)axbxc	Koli Ağırlığı (kg)	Koli Adedi	Fiyat
110679	2x10	6 V 4500 mAh	30h	6h	4000	340x480x150	6,7	1	178,00\$

Özellikler     
   

IP65 Acil Aydınlatma Armatürü

Ausled

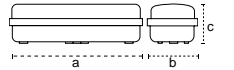

Kod	Tip	Güç (W)	Batarya	Şarj Süresi	Deşarj Süresi	Işık Akısı (lm)	Renk Sıcaklığı (K)	Etkinlik Faktörü (lm/W)	Boyutlar (mm)axbxc	Koli Ağırlığı (kg)	Koli Adedi	Fiyat
115138	AC	10	-	24h	3h	1000	6500	100	350x117x76	10,4	12	25,50\$
115140	DC	3	3,7V 3500mAh	24h	3h	300	6500	100	350x117x76	10,4	12	45,70\$
108390	AC/DC	5	3,7V 3500mAh	24h	3h	500	6500	100	350x117x76	10,4	12	49,00\$
110667	AC/DC	10	3,7V 3500mAh	24h	3h	1000	6500	100	350x117x76	10,4	12	54,00\$

CE

Özellikler     

Opsiyonlar 

Yeni Ürün



Metal Emergency Spot

Emera

Kod	Güç (W)	Batarya	Şarj Süresi	Deşarj Süresi	Renk Sıcaklığı (K)	Boyutlar (mm)axbxc	Koli Ağırlığı (kg)	Koli Adedi	Fiyat
116863	10	6 V 4500 mAh	30h	6h	4000	222x300x80	10,2	6	76,00\$

Özellikler	Metal	PMMA Difüzör	4000/6500K	IP40	LED Çip Ömrü 50.000h
	Şarj Göstergesi	Deşarj Göstergesi	Anahtar ve Test Butonu	Taşınabilir, Asılabilir	

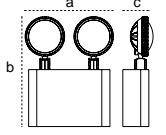

2x5W

2x10W

Metal Emergency Spot

Emera

Kod	Güç (W)	Batarya	Şarj Süresi	Deşarj Süresi	Renk Sıcaklığı (K)	Boyutlar (mm)axbxc	Koli Ağırlığı (kg)	Koli Adedi	Fiyat
109781	2x5	6 V 4500 mAh	30h	6h	4000	275x340x80	10,8	4	81,00\$
109780	2x10	6 V 4500 mAh	30h	6h	4000	325x340x80	12	4	140,00\$

Özellikler	Metal	PMMA Difüzör	4000/6500K	IP40	LED Çip Ömrü 50.000h
	Şarj Göstergesi	Deşarj Göstergesi	Anahtar ve Test Butonu	Taşınabilir, Asılabilir	

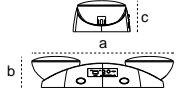

2x3W

Emergency Spot

Rotara

Kod	Güç (W)	Batarya	Şarj Süresi	Deşarj Süresi	Renk Sıcaklığı (K)	Boyutlar (mm)axbxc	Koli Ağırlığı (kg)	Koli Adedi	Fiyat
203911	2x3	4 V 2000 mAh	24h	4h	4000	261x89x59	6,4	10	46,50\$

Özellikler	Plastik	PMMA Difüzör	4000K	IP40	LED Çip Ömrü 50.000h
	Şarj Göstergesi	Deşarj Göstergesi	Anahtar ve Test Butonu	Taşınabilir, Asılabilir	

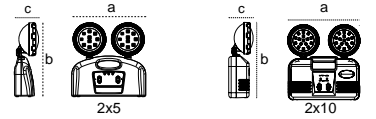

2x5W

2x10W

Emergency Spot

Rotara

Kod	Güç (W)	Batarya	Şarj Süresi	Deşarj Süresi	Renk Sıcaklığı (K)	Boyutlar (mm)axbxc	Koli Ağırlığı (kg)	Koli Adedi	Fiyat
203913	2x5	4 V 2000 mAh	24h	4h	4000	280x279x89	9,5	8	71,50\$
203907	2x10	6 V 3000 mAh	24h	6h	4000	286x299x89	12,7	8	115,00\$

Özellikler	Polimer Enjeksiyon	PMMA Difüzör	4000K	IP40	LED Çip Ömrü 50.000h
	Şarj Göstergesi	Deşarj Göstergesi	Anahtar Butonu	Taşınabilir, Asılabilir	



Acil Aydınlatma Armatürü

Alerna

Kod	Tip	Batarya	Şarj Süresi	Deşarj Süresi	Renk Sıcaklığı (K)	Boyutlar (mm)axbxc	Koli Ağırlığı (kg)	Koli Adedi	Fiyat
204619	30 LED	3,7V 1,2Ah Ni-Cd	24h	8h	6500	203x55x29	7,5	40	9,50\$
204620	60 LED	3,7V 2,2Ah Ni-Cd	24h	8h	6500	342x55x29	7,5	24	16,40\$
204623	90 LED	2x3,7V 2,0Ah Ni-Cd	24h	8h	6500	482x55x29	7,5	20	26,60\$
209039	120 LED	2x3,7V 2,2Ah Ni-Cd	24h	8h	6500	482x55x29	7,5	20	35,65\$

Özellikler	Polimer Enjeksiyon	Plastik Difüzör	6500K	IP40	30.000h
	Şarj Göstergesi	Deşarj Göstergesi	Anahtar ve Test Butonu	Taşınabilir, Asılabilir	

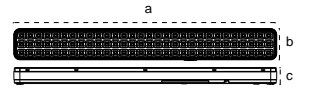

Solar Işıldak

Kod	Tip	Batarya	Şarj Süresi	Deşarj Süresi	Renk Sıcaklığı (K)	Boyutlar (mm)axbxc	Koli Ağırlığı (kg)	Koli Adedi	Fiyat
206489	30 LED	4 V 2000 mAh	24h	8h	6500	140x64x46	4	20	15,10\$

Özellikler	Polimer Enjeksiyon	Plastik Difüzör	6500K	IP20	30.000h
	Anahtar ve Test Butonu	Taşınabilir, Asılabilir			

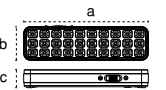

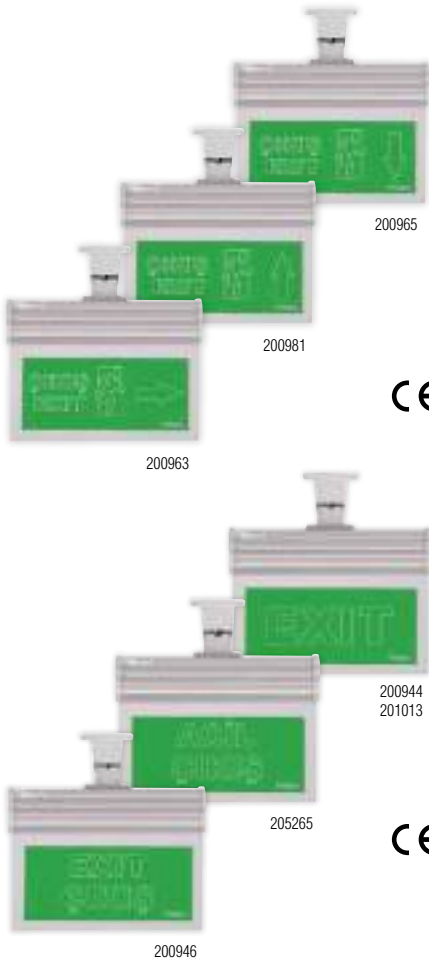

Alüminyum Gövde

Tek ve Çift Yön
Kullanım OpsiyonuSıva Altı, Sıva Üstü
Sarkıt Montaj Opsiyonu

Vialed (3 saat)

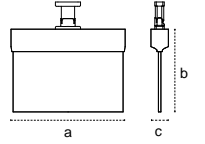

Kod	Tip	Güç (W)	Batarya	Şarj Süresi	Deşarj Süresi	Renk Sıcaklığı (K)	Boyutlar (mm)axbxc	Koli Ağırlığı (kg)	Koli Adedi	Fiyat
200965	Çift Yön	3	1000 mAh 1.2 Ni-Mh	24h	3h	6500	280x205x42	11	10	35,75\$
200981	Çift Yön	3	1000 mAh 1.2 Ni-Mh	24h	3h	6500	280x205x42	11	10	35,75\$
200963	Çift Yön	3	1000 mAh 1.2 Ni-Mh	24h	3h	6500	280x205x42	11	10	35,75\$



Özellikler



Alüminyum



PMMA Difüzör



IP20



50.000h



Şarj Göstergesi



Deşarj Göstergesi

Vialed (3 saat)

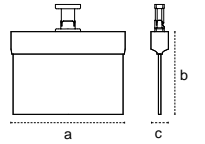

Kod	Tip	Güç (W)	Batarya	Şarj Süresi	Deşarj Süresi	Renk Sıcaklığı (K)	Boyutlar (mm)axbxc	Koli Ağırlığı (kg)	Koli Adedi	Fiyat
200944	Tek Yön	3	1000 mAh 1.2 Ni-Mh	24h	3h	6500	280x205x42	11	10	35,75\$
201013	Çift Yön	3	1000 mAh 1.2 Ni-Mh	24h	3h	6500	280x205x42	11	10	35,75\$
205265	Çift Yön	3	1000 mAh 1.2 Ni-Mh	24h	3h	6500	280x205x42	11	10	35,75\$
200946	Tek Yön	3	1000 mAh 1.2 Ni-Mh	24h	3h	6500	280x205x42	11	10	35,75\$



Özellikler



Alüminyum



PMMA Difüzör



IP20



50.000h



Şarj Göstergesi



Deşarj Göstergesi

Rausled (3 saat) IP65

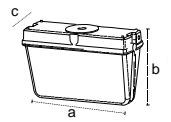

Kod	Tip	Güç (W)	Batarya	Şarj Süresi	Deşarj Süresi	Işık Akısı (lm)	Renk Sıcaklığı (K)	Etkinlik Faktörü (lm/W)	Boyutlar (mm)axbxc	Koli Ağırlığı (kg)	Koli Adedi	Fiyat
113621	Sıva Üstü	5	3,7V 3500mAh	24h	3h	500	6500	100	350x117x218	5,5	6	61,00\$



4 Farklı Yön Etiketli



Özellikler



Polimer Enjeksiyon



PC Difüzör



3000/4000/6500K



IP65



50.000h

Opsiyonlar



DALI

Rutaled

Ekonomik Çözüm

Rutaled



PVC Gövde



Tek ve Çift Yön
Kullanım Opsiyonu



Sıva Altı, Sıva Üstü
Sarkıt Montaj Opsiyonu



Yeni Ürün



Rutaled

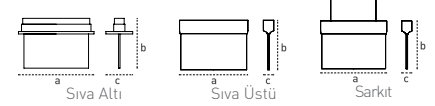

Kod	Tip	Güç (W)	Batarya	Şarj Süresi	Deşarj Süresi	Renk Sıcaklığı (K)	Boyutlar (mm)axbxc	Koli Ağırlığı (kg)	Koli Adedi	Fiyat
212217	Çift Yön	3	1000 mAh 1.2 Ni-Mh	24h	3h	6500	280x205x42	7	10	29,50\$
212218	Çift Yön	3	1000 mAh 1.2 Ni-Mh	24h	3h	6500	280x205x42	7	10	29,50\$
212219	Çift Yön	3	1000 mAh 1.2 Ni-Mh	24h	3h	6500	280x205x42	11	10	29,50\$

Özellikler

- PVC
- PMMA Difüzör
- IP20
- 50.000h
- Şarj Göstergesi
- Deşarj Göstergesi

Yeni Ürün



Rutaled

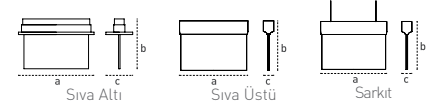

Kod	Tip	Güç (W)	Batarya	Şarj Süresi	Deşarj Süresi	Renk Sıcaklığı (K)	Boyutlar (mm)axbxc	Koli Ağırlığı (kg)	Koli Adedi	Fiyat
212064	Çift Yön	3	1000 mAh 1.2 Ni-Mh	24h	3h	6500	280x205x42	7	10	29,50\$
212220	Çift Yön	3	1000 mAh 1.2 Ni-Mh	24h	3h	6500	280x205x42	7	10	29,50\$
212221	Çift Yön	3	1000 mAh 1.2 Ni-Mh	24h	3h	6500	280x205x42	11	10	29,50\$

Özellikler

- PVC
- PMMA Difüzör
- IP20
- 50.000h
- Şarj Göstergesi
- Deşarj Göstergesi



Exiled (3 saat)

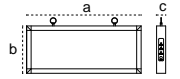

Kod	Tip	Güç (W)	Batarya	Şarj Süresi	Deşarj Süresi	Renk Sıcaklığı (K)	Boyutlar (mm)axbxc	Koli Ağırlığı (kg)	Koli Adedi	Fiyat
203885	Çift Yön	3	800 mAh 1.2 Ni-Cd	24h	3h	6500	360x150x24	6,8	20	11,90\$
203891	Tek Yön	3	800 mAh 1.2 Ni-Cd	24h	3h	6500	360x150x24	6,8	20	11,90\$
203888	Çift Yön	3	800 mAh 1.2 Ni-Cd	24h	3h	6500	360x150x24	6,8	20	11,90\$
203889	Çift Yön	3	800 mAh 1.2 Ni-Cd	24h	3h	6500	360x150x24	6,8	20	11,90\$

Özellikler

- Alüminyum
- Şeffaf Cam
- IP20
- 30.000h
- Şarj Göstergesi
- Deşarj Göstergesi
- Test Butonu



Exiled (3 saat)

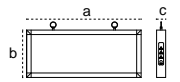

Kod	Tip	Güç (W)	Batarya	Şarj Süresi	Deşarj Süresi	Renk Sıcaklığı (K)	Boyutlar (mm)axbxc	Koli Ağırlığı (kg)	Koli Adedi	Fiyat
203887	Çift Yön	3	800 mAh 1.2 Ni-Cd	24h	3h	6500	360x150x24	6,8	20	11,90\$
203890	Çift Yön	3	800 mAh 1.2 Ni-Cd	24h	3h	6500	360x150x24	6,8	20	11,90\$
205688	Çift Yön	3	800 mAh 1.2 Ni-Cd	24h	3h	6500	360x150x24	11	20	11,90\$

Özellikler

- Alüminyum
- Şeffaf Cam
- IP20
- 30.000h
- Şarj Göstergesi
- Deşarj Göstergesi
- Test Butonu



Taşınabilir Güç Kaynağı

Pelsan

ENERJİNİZ BİTMESİN

Voltiron ile uzun yolculuklarda ve elektrik hatlarının bulunmadığı zorlu endüstriyel alanlarda yeterli elektriği sağlayabilirsiniz.

Taşınabilir güç kaynağı ile enerjiniz bitmesin!

1000W



Voltiron

**LANSMANA
ÖZEL
~~1.229,00\$~~**

979,00 \$

13 CİHAZA
KADAR
BESLEME İMKANI



LED EKRAN



LED IŞILDAK



KABLOSUZ ŞARJ



2 SAATTE
HIZLI ŞARJ



3
FARKLI
ŞARJ YÖNTEMİ



**HAFİF
TAŞINABİLİR**



AKILLI BATARYA

BMS (Batarya Management System)
devreleri ile güvenli kullanım teknolojisi



Yüksek Batarya Kapasitesi

1089W

Çevre dostu lityum pilleri ile hafif ve taşınabilir.



Voltiron

Taşınabilir Güç Kaynağı

Kod	Güç (W)	Koli Adedi	Fiyat
209726	1000	1	979,00\$

Largo G2
Etanj Armatür



Geniş Güç / Lümen Paketi

14-100W

1820-12400lm



140lm/W'a Varan Verimlilik

%61'e varan tasarruf



Sahada Bakım Kolaylığı

(Sürücü / Işık Kaynağı Kolay Değişir)



5 Yıl Garanti

Uzun Ömür, Yüksek Performans



Paslanmaz Metal

Mandal ve Montaj Aparatı



600mm

1200mm

1500mm

Largo G2

Etanj

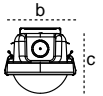

Kod	Güç (W)	Renk Sıcaklığı (K)	Işık Akısı (lm)	Etkinlik Faktörü (lm/W)	Boyutlar (mm)axbxc	Koli Ağırlığı (kg)	Koli Adedi	Fiyat
115957	14	6500	1820	130	610x80x75	7,8	6	27,60\$
115787	20	6500	2500	125	610x80x75	7,8	6	27,60\$
115963	27	6500	3159	117	610x80x75	7,8	6	29,90\$
116061	26	6500	3458	133	1150x80x75	14,7	6	32,80\$
116062	34	6500	4420	130	1150x80x75	14,7	6	32,80\$
116063	50	6500	6100	122	1150x80x75	14,7	6	61,20\$
116064	75	6500	8550	114	1150x80x75	14,7	6	79,40\$
116067	100	6500	11200	112	1500x80x75	19,1	6	92,50\$



Özellikler



PC



PC Diffüzör



3000/4000/6500K



IP65



50.000h



5 Yıl

Opsiyonlar



DALI



1-10V



Acil Aydınlatma (1-3 saat)



Radar Sensör



Busbar







Sarkit





Toz ve Su Almaz

-  Yıkanabilir, solvante dayanıklıdır
-  Difüzörü asla sararmaz
-  Işığı istediği noktaya yönlendirme
-  Geniş lümen paketi, 2033-18750lm
-  Sürekli üstün performans

Inovaled G3

Temperli Cam Alüminyum Etanj



Yeni Ürün

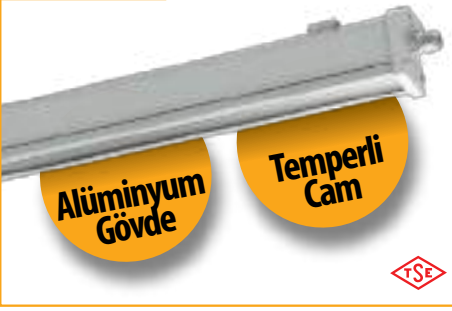





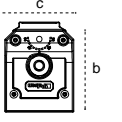
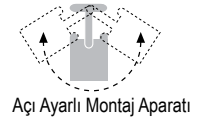



Inovaled G3

Temperli Cam Alüminyum Etanj



Kod	Güç (W)	Renk Sıcaklığı (K)	Işık Akısı (lm)	Etkinlik Faktörü (lm/W)	Boyutlar (mm)axbxc	Koli Ağırlığı (kg)	Koli Adedi	Fiyat	
116583	19	6500	2033	107	630x72x59	8,6	6	61,50\$	
116584	26	6500	2782	107	910x72x59	10,7	6	94,55\$	
116585	34	6500	3672	108	1190x72x59	14,7	6	113,80\$	
333644	Açı ayarlı montaj aparatı (2'li)							1	3,50\$

Özellikler	 Alüminyum	 Temperli Cam	 3000/4000/6500K	 IP66	 50.000h	 5 Yıl
Opsiyonlar	 DALI	 1-10V	 Acil Aydınlatma (1-3 saat)			

Yeni Ürün

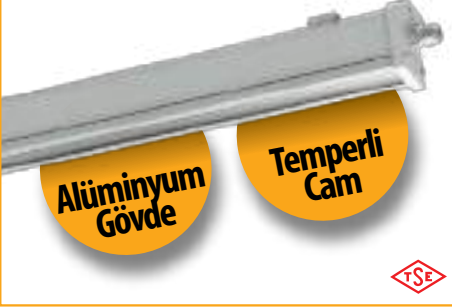

Inovaled Max

Temperli Cam Alüminyum Etanj

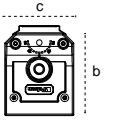

Kod	Güç (W)	Renk Sıcaklığı (K)	Işık Akısı (lm)	Etkinlik Faktörü (lm/W)	Boyutlar (mm)axbxc	Koli Ağırlığı (kg)	Koli Adedi	Fiyat	
116580	100	6500	12300	123	910x72x59	10,7	6	116,25\$	
116581	120	6500	15000	125	1190x72x59	14,7	6	141,50\$	
116582	150	6500	18750	125	1470x72x59	19,7	6	154,25\$	
333644	Açı ayarlı montaj aparatı (2'li)							1	3,50\$

Özellikler	 Alüminyum	 Temperli Cam	 3000/4000/6500K	 IP66	 50.000h	 5 Yıl
Opsiyonlar	 DALI	 Acil Aydınlatma (1-3 saat)	 Busbar			



Prota G3

Alüminyum Etanj

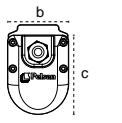

Kod	Güç (W)	Renk Sıcaklığı (K)	Işık Akısı (lm)	Etkinlik Faktörü (lm/W)	Boyutlar (mm)axbxc	Koli Ağırlığı (kg)	Koli Adedi	Fiyat
115014	18	6500	2250	125	555x64x46	7	12	34.65\$
115016	23	6500	2921	127	805x64x46	9,5	12	43.70\$
115018	33	6500	4125	125	1055x64x46	11,5	12	54.40\$
115020	43	6500	5504	128	1305x64x46	14	12	63.50\$

Özellikler	 Alüminyum	 Opal Difüzör	 3000/4000/6500K	 IP65	 50.000h	 5 Yıl
Opsiyonlar	 DALI	 1-10V	 Acil Aydınlatma (1-3 saat)			

Rigo

Ekonomik Çözüm
Rigo

ŞOK FİYAT
25,00 \$



Rigo
Etanj

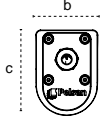

Kod	Güç (W)	Renk Sıcaklığı (K)	Işık Akısı (lm)	Etkinlik Faktörü (lm/W)	Boyutlar (mm)axbxc	Koli Ağırlığı (kg)	Koli Adedi	Fiyat
117147	20	6500	2100	105	650x72x50	3,3	8	25,00\$
117145	36	6500	3780	105	1250x72x50	6	8	26,00\$

- Özellikler** PC Opal Difüzör 3000/4000/6500K IP65 50.000h 2 Yıl
- Opsiyonlar** Acil Aydınlatma (1-3 saat)



Otopark Fonksiyonu

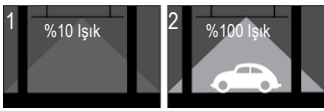

Largo

Otopark Fonksiyonlu Etanj

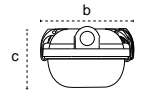

Kod	Güç (W)	Renk Sıcaklığı (K)	Işık Akısı (lm)	Etkinlik Faktörü (lm/W)	Boyutlar (mm)axbxc	Koli Ağırlığı (kg)	Koli Adedi	Fiyat
113489	36	6500	3960	110	1273x85x85	10	6	126,00\$

- Özellikler** GRP PC Difüzör 3000/4000/6500K IP65 50.000h
- Opsiyonlar** Acil Aydınlatma (1-3 saat) Busbar



Largo Frozen

Soğuk Hava Deposu Etanji

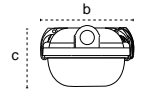

Kod	Güç (W)	Renk Sıcaklığı (K)	Işık Akısı (lm)	Etkinlik Faktörü (lm/W)	Boyutlar (mm)axbxc	Koli Ağırlığı (kg)	Koli Adedi	Fiyat
105884	42	6500	4620	110	1273x85x85	15	6	230,10\$
105894	63	6500	6930	110	1573x85x85	16	6	241,60\$

- Özellikler** GRP PC Difüzör 3000/4000/6500K IP65 50.000h
- Opsiyonlar** Busbar



-40°C'ye Kadar Çalışır.
Soğuk hava depoları ve donuk ürün depoları kullanımı için uygundur.



Tekli
Duy

Largo

LED Tube Etanj x1

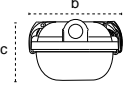

Kod	Duy	Renk Sıcaklığı (K)	Işık Akısı (lm)	Etkinlik Faktörü (lm/W)	Boyutlar (mm)axbxc	Koli Ağırlığı (kg)	Koli Adedi	Fiyat
102669	G13	-	-	-	663x85x85	11	6	16,75\$
102713	G13	-	-	-	1273x85x85	17	6	22,75\$
102867	G13	-	-	-	1573x85x85	21,5	6	39,50\$



Özellikler	GRP	Seffaf Difüzör	IP65
Opsiyonlar	Acil Aydınlatma (1 saat)	Busbar	

Çiftli
Duy

Largo

LED Tube Etanj x2

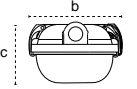

Kod	Duy	Renk Sıcaklığı (K)	Işık Akısı (lm)	Etkinlik Faktörü (lm/W)	Boyutlar (mm)axbxc	Koli Ağırlığı (kg)	Koli Adedi	Fiyat
102687	2xG13	-	-	-	663x85x125	12,8	6	17,50\$
102744	2xG13	-	-	-	1273x85x125	18,5	6	24,00\$
102878	2xG13	-	-	-	1573x85x125	25	6	42,50\$



Özellikler	GRP	Seffaf Difüzör	IP65
Opsiyonlar	Acil Aydınlatma (1 saat)	Busbar	



LED Tube 18W 1200mm

Kod	Güç (W)	Renk Sıcaklığı (K)	Işık Akısı (lm)	Etkinlik Faktörü (lm/W)	Enerji Tüketimi (kwh/1000h)	Boyutlar (mm)axbxc	Koli Ağırlığı (kg)	Koli Adedi	Fiyat
314665	18	6500	1800	100	18	1214x26	8,6	25	5,00\$



Özellikler	Cam	Opal Difüzör	4000/6500K	30.000h
------------	-----	--------------	------------	---------



LED Tube 22W 1500mm

Kod	Güç (W)	Renk Sıcaklığı (K)	Işık Akısı (lm)	Etkinlik Faktörü (lm/W)	Enerji Tüketimi (kwh/1000h)	Boyutlar (mm)axbxc	Koli Ağırlığı (kg)	Koli Adedi	Fiyat
314668	22	6500	2220	101	22	1510x26	10,5	25	10,40\$



Özellikler	Cam	Opal Difüzör	4000/6500K	30.000h
------------	-----	--------------	------------	---------



110 V_{ac}

110Vac Ria Med G2

Projektör

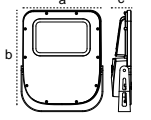

Kod	Güç (W)	Renk Sıcaklığı (K)	Işık Akısı (lm)	Etkinlik Faktörü (lm/W)	Boyutlar (mm)axbxc	Koli Ağırlığı (kg)	Koli Adedi	Fiyat
111788	60	6500	8820	147	340x274x66	15,05	4	126,00\$
111785	80	6500	11360	142	340x274x66	15,05	4	160,00\$
111660	100	6500	13900	138	340x274x66	15,05	4	160,00\$
111666	150	6500	19050	127	340x274x66	15,05	4	187,00\$
116136	200	6500	26000	130	340x274x66	15,05	4	300,00\$



Özellikler Alüminyum Temperli Cam 3000/4000/6500K IP66 62.000h

Opsiyonlar 30°/60°/90°/Asimetrik*

*Asimetrik Lens 50-150W arasında bulunmaktadır.



110 V_{ac}

110Vac Doka G2

Yol ve Cadde Armatürü

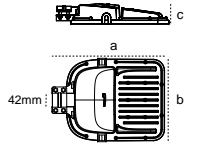

Kod	Güç (W)	Renk Sıcaklığı (K)	Işık Akısı (lm)	Etkinlik Faktörü (lm/W)	Boyutlar (mm)axbxc	Konsol	Koli Ağırlığı (kg)	Koli Adedi	Fiyat
115410	60	4000	8820	147	362x268x65x316	42	11,8	4	151,00\$
115412	80	4000	11360	142	362x268x65x316	42	11,8	4	165,00\$
115414	100	4000	13800	138	362x268x65x316	42	11,8	4	165,00\$
115416	150	4000	19050	127	362x268x65x316	42	11,8	4	215,00\$
116241	200	4000	26000	130	362x268x65x316	42	11,8	4	330,00\$



Özellikler Alüminyum Temperli Cam 3000/4000/6500K IP66 62.000h



24 V_{dc}

24Vdc Sterio

IP66 Projektör

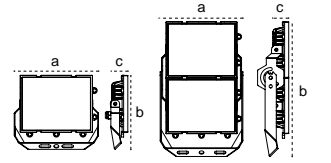

Kod	Güç (W)	Renk Sıcaklığı (K)	Işık Akısı (lm)	Etkinlik Faktörü (lm/W)	Boyutlar (mm)axbxc	Koli Ağırlığı (kg)	Koli Adedi	Fiyat
110171	50	5700	5000	100	225x195x59	8,75	6	74,50\$
110506	100	5700	10000	100	225x365x85	10	4	134,00\$



Özellikler Alüminyum Temperli Cam 5700K IP66 30.000h

Opsiyonlar Marin Boya



24 V_{dc/ac}

24Vdc/ac Trada

Lineer Armatür / Projektör

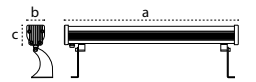

Kod	Tip	Güç (W)	Renk Sıcaklığı (K)	Işık Akısı (lm)	Etkinlik Faktörü (lm/W)	Boyutlar (mm)axbxc	Koli Ağırlığı (kg)	Koli Adedi	Fiyat
209187	Lineer	8	6500	728	91	185x56x87	0,46	1	51,30\$
209190	Lineer	16	6500	1600	100	245x56x87	0,75	1	58,70\$
209193	Lineer	24	6500	2328	97	495x56x87	1,02	1	87,20\$
209183	Projektör	24	6500	2328	97	205x155x100	1,35	1	127,30\$
209184	Projektör	38	6500	3724	98	369x155x100	2,24	1	190,30\$



Özellikler Alüminyum Temperli Cam 3000/4000/6500K IP67 50.000h





Lenta

IP65 Kanopi Armatür



Sıva Üstü Farkı
19.00 \$

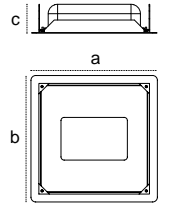

Kod	Güç (W)	Renk Sıcaklığı (K)	Işık Akısı (lm)	Etkinlik Faktörü (lm/W)	Boyutlar (mm)axbxc	Koli Ağırlığı (kg)	Koli Adedi	Fiyat
110507	100	5000	10000	100	400x400x88	5,2	1	123,00\$
116325	150	5000	19500	130	400x400x88	5,2	1	171,00\$

Özellikler  Alüminyum  Temperli Cam  3000K  IP65  30.000h



Okta

IP65 Kanopi Armatür

Lens Farkı
28.00 \$

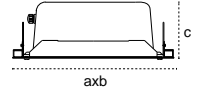

Kod	Güç (W)	Renk Sıcaklığı (K)	Işık Akısı (lm)	Etkinlik Faktörü (lm/W)	Boyutlar (mm)axbxc	Koli Ağırlığı (kg)	Koli Adedi	Fiyat
106627	80	6500	11200	140	400x400x140	4,8	1	171,00\$
110173	100	6500	11000	110	400x400x100	4,8	1	212,00\$

Özellikler  Alüminyum  Temperli Cam  3000/4000/6500K  IP65  50.000h

Opsiyonlar  DALI  Acil Aydınlatma (1-3 saat)



Piroliz

IP65 Kanopi Armatür

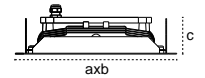

Kod	Güç (W)	Renk Sıcaklığı (K)	Işık Akısı (lm)	Etkinlik Faktörü (lm/W)	Boyutlar (mm)axbxc	Koli Ağırlığı (kg)	Koli Adedi	Fiyat
109937	75	6500	12000	160	395x385x132	8	1	369,00\$
109938	100	6500	15500	155	395x385x132	8	1	369,00\$
109939	125	6500	19000	152	395x385x132	8	1	369,00\$

Özellikler  Alüminyum  Temperli Cam  3000/4000/6500K  IP65  50.000h  5 Yıl

Opsiyonlar  DALI  Acil Aydınlatma (1-3 saat)  30° / 60° / 90°



Piroliz Ex-Proof

IP65 Kanopi Armatür

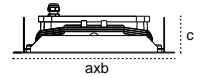

Kod	Güç (W)	Renk Sıcaklığı (K)	Işık Akısı (lm)	Etkinlik Faktörü (lm/W)	Boyutlar (mm)axbxc	Koli Ağırlığı (kg)	Koli Adedi	Fiyat
111376	50	6500	8250	165	395x385x132	8	1	398,00\$
111375	75	6500	12000	160	395x385x132	8	1	450,00\$
111374	100	6500	15500	155	395x385x132	8	1	502,00\$
111382	125	6500	19000	152	395x385x132	8	1	553,00\$
111373	150	6500	22500	150	395x385x132	8	1	604,00\$
111056	200	6500	28600	143	395x385x132	8	1	667,00\$

Özellikler  Alüminyum  Temperli Cam  3000/4000/6500K  IP66  50.000h

Opsiyonlar  DALI  30° / 60° / 90°

Gaz patlama koruması : II 3G Ex ec IIC T5 Gc
Toz patlama koruması : II 3D Ex tc IIC (T95 °C) Dc



Türkiye Petrolleri
Antalya / Kepez



Total
Kastamonu / Merkez



Opet
Kocaeli / Darıca



Shell
Bursa / İnegöl

Cronto IP66

En zor koşullarda 7/24 **yüksek performans**



IP66
Toz ve Su Almaz



IK10
Darbe Dayanımı



Lens Opsiyonları
30° / 60° / 90° / Asimetrik

Driver
Üstünlükleri



ENEC Belgesi
Sürücü



100.000 h
Driver Ömrü



10kV Dahili
Parafudr



-40°C +55°C



IP67



100-277Vac
Gerilim Dalgalanmalarından Etkilenmez



Ta= +70°C Opsiyon

Cronto 150-200W

Kod	Güç (W)	Renk Sıcaklığı (K)	Işık Akısı (lm)	Etkinlik Faktörü (lm/W)	Boyutlar (mm)axbxc	Koli Ağırlığı (kg)	Koli Adedi	Fiyat
111333	150	5700	22350	149	230x555x135	12	1	357,00\$
111334	200	5700	28800	144	230x555x135	12	1	378,00\$



Özellikler



Alüminyum



Temperli Cam



4000/5700/6500K



IP66



62.000h



5 Yıl

Opsiyonlar



DALI



1-10V



Step DIM



Acil Aydınlatma (1-3 saat)



Radar Sensör



Busbar



30° / 60° / 90°

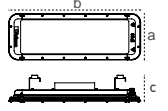

Ta= +70°C Opsiyon

Cronto 250-300W

Kod	Güç (W)	Renk Sıcaklığı (K)	Işık Akısı (lm)	Etkinlik Faktörü (lm/W)	Boyutlar (mm)axbxc	Koli Ağırlığı (kg)	Koli Adedi	Fiyat
111331	250	5700	36000	144	230x655x135	15	1	472,50\$
111332	300	5700	42300	141	230x655x135	15	1	472,50\$



Özellikler



Alüminyum



Temperli Cam



4000/5700/6500K



IP66



62.000h



5 Yıl

Opsiyonlar



DALI



1-10V



Step DIM



Acil Aydınlatma (1-3 saat)



Radar Sensör



Busbar



30° / 60° / 90°

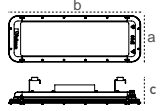

Ta= +70°C Opsiyon

Cronto 350-400W

Kod	Güç (W)	Renk Sıcaklığı (K)	Işık Akısı (lm)	Etkinlik Faktörü (lm/W)	Boyutlar (mm)axbxc	Koli Ağırlığı (kg)	Koli Adedi	Fiyat
111335	350	5700	48650	139	230x760x135	19	1	625,50\$
111336	400	5700	54800	137	230x760x135	19	1	625,50\$



Özellikler



Alüminyum



Temperli Cam



4000/5700/6500K



IP66



62.000h



5 Yıl

Opsiyonlar



DALI



1-10V



Step DIM



Acil Aydınlatma (1-3 saat)



Radar Sensör



Busbar



30° / 60° / 90°

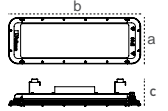

Pelsan

ETNA,
Yenilenen G3 Serisi ile

Şimdi 170lm/W

170lm/W

-40 / +70

10kV
Dahili Parafudr

120000h
Sürücü Ömrü

IP65
Toz ve Su Almaz

100-277Vac

DALI

DALI

1-10V

1-10V

Radar Sensör

Radar Sensör

Etna G3

CS Serisi

- Tasarruflu
- Hızlı Amortisman
- Endüstriyel Tesis

HEC Serisi

- +70°C'ye Kadar Yüksek Performans
- Ağır Sanayi Tesisleri
- 7/24 Çalışma
- Dayanıklı Gövde

HLO Serisi

- Enerji Verimliliği
- Sürdürülebilirlik
- Verimlilik

FF Serisi

- Gıda Tesisleri
- Yüksek Güvenlik
- Temperli Filmlerli Cam



Etna G3L

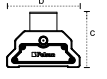

Kod	Tip	Güç (W)	Renk Sıcaklığı (K)	Işık Akısı (lm)	Etkinlik Faktörü (lm/W)	Boyutlar (mm)axbxc	Koli Ağırlığı (kg)	Koli Adedi	Fiyat
116898	90°	75	5700	12150	162	440x163x141	3	1	148,00\$
116902	90°	100	5700	16500	165	640x163x141	4	1	172,00\$
116901	90°	125	5700	20000	160	840x163x141	4,9	1	240,00\$
116900	90°	150	5700	24300	162	840x163x141	4,9	1	240,00\$
116899	90°	200	5700	32200	161	1040x163x141	5,6	1	355,00\$

- Özellikler** Alüminyum Temperli Cam 4000/5700/6500K IP65 120.000h 5 Yıl
- Opsiyonlar** DALI 1-10V Acil Aydınlatma (1-3 saat) Radar Sensör Busbar



Etna G3L HLO

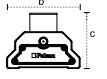

Kod	Tip	Güç (W)	Renk Sıcaklığı (K)	Işık Akısı (lm)	Etkinlik Faktörü (lm/W)	Boyutlar (mm)axbxc	Koli Ağırlığı (kg)	Koli Adedi	Fiyat
116904	90°	50	5700	8300	166	440x163x141	3	1	175,50\$
116903	90°	75	5700	12750	170	640x163x141	4	1	227,50\$
116906	90°	100	5700	16600	166	840x163x141	4,9	1	267,50\$
116905	90°	150	5700	24750	165	1040x163x141	5,6	1	308,50\$

- Özellikler** Alüminyum Temperli Cam 4000/5700/6500K IP65 120.000h 5 Yıl
- Opsiyonlar** DALI 1-10V Acil Aydınlatma (1-3 saat) Radar Sensör Busbar



Etna G3L HEC

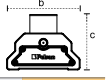

Kod	Tip	Güç (W)	Renk Sıcaklığı (K)	Işık Akısı (lm)	Etkinlik Faktörü (lm/W)	Boyutlar (mm)axbxc	Koli Ağırlığı (kg)	Koli Adedi	Fiyat
116937	90°	50	5700	8300	166	440x163x141	3	1	175,50\$
116938	90°	75	5700	12750	170	640x163x141	4	1	227,50\$
116939	90°	100	5700	16600	166	840x163x141	4,9	1	267,50\$
116940	90°	150	5700	24750	165	1040x163x141	5,6	1	308,50\$

- Özellikler** Alüminyum Temperli Cam 4000/5700/6500K IP65 120.000h 5 Yıl
- Opsiyonlar** DALI 1-10V Acil Aydınlatma (1-3 saat) Radar Sensör Busbar



Etna G3L FF

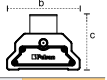

Kod	Tip	Güç (W)	Renk Sıcaklığı (K)	Işık Akısı (lm)	Etkinlik Faktörü (lm/W)	Boyutlar (mm)axbxc	Koli Ağırlığı (kg)	Koli Adedi	Fiyat
116907	90°	75	5700	12150	162	440x163x141	3	1	199,00\$
116911	90°	100	5700	16500	165	640x163x141	4	1	223,00\$
116910	90°	125	5700	20000	160	840x163x141	4,9	1	291,00\$
116909	90°	150	5700	24300	162	840x163x141	4,9	1	291,00\$
116908	90°	200	5700	32200	161	1040x163x141	5,6	1	406,00\$

- Özellikler** Alüminyum Filmlü Temperli Cam 4000/5700/6500K IP65 90.000h 5 Yıl
- Opsiyonlar** DALI 1-10V Acil Aydınlatma (1-3 saat) Radar Sensör Busbar



Etna G3L CS

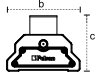

Kod	Tip	Güç (W)	Renk Sıcaklığı (K)	Işık Akısı (lm)	Etkinlik Faktörü (lm/W)	Boyutlar (mm)axbxc	Koli Ağırlığı (kg)	Koli Adedi	Fiyat
116915	90°	100	5700	15700	157	440x163x141	3	1	151,00\$
116914	90°	150	5700	23850	159	640x163x141	4	1	211,00\$
116913	90°	200	5700	31400	157	840x163x141	4,9	1	317,00\$
116912	90°	240	5700	37200	155	1040x163x141	5,6	1	373,00\$

- Özellikler** Alüminyum Temperli Cam 4000/5700/6500K IP65 120.000h 5 Yıl
- Opsiyonlar** DALI 1-10V Acil Aydınlatma (1-3 saat) Radar Sensör Busbar

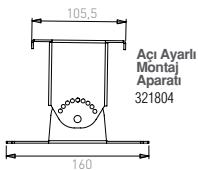
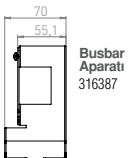

Kod	Özellikler	Koli Adedi	Fiyat
316387	Etna G2/ Hima G2/ Karpat G3 Busbar Askı Takımı	1	7.30\$
321804	Etna G2/ Hima G2/ Karpat G3 Acı Ayarlı Bağlantı Takımı	1	10.30\$





140lm/W'a
Varan Verimlilik

Hızlı amortisman

Yeni Ürün



Hima G3

Kod	Güç (W)	Renk Sıcaklığı (K)	Işık Akısı (lm)	Etkinlik Faktörü (lm/W)	Boyutlar (mm)axbxc	Koli Ağırlığı (kg)	Koli Adedi	Fiyat
116941	75	6500	10500	140	585x146x130	4,5	1	90,50\$
116942	110	6500	15400	140	865x146x130	4,5	1	119,50\$
116943	150	6500	21000	140	1145x146x130	6	1	142,50\$

Özellikler	Alüminyum	Alüminyum Reflektör	Temperli Cam	4000/5700/6500K	IP65	50.000h
Opsiyonlar	DALI	1-10V	Acil Aydınlatma (1-3 saat)	Radar Sensör	Busbar	

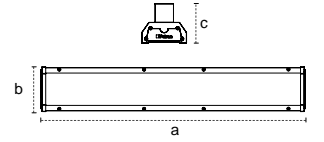

Yeni Ürün



Karpas G4

Kod	Güç (W)	Renk Sıcaklığı (K)	Işık Akısı (lm)	Etkinlik Faktörü (lm/W)	Boyutlar (mm)axbxc	Koli Ağırlığı (kg)	Koli Adedi	Fiyat
117102	75	6500	9150	122	600x110x60	4,4	2	59,50\$
117127	110	6500	13860	126	880x110x60	6,5	2	93,00\$
117124	140	6500	17500	125	1160x110x60	8	2	119,00\$
116489	180	6500	22320	124	882x207x65	5,5	1	210,00\$

Özellikler	Metal / Alüminyum	Temperli Cam	3000/4000/6500K	IP65	50.000h
Opsiyonlar	DALI	1-10V	Acil Aydınlatma (1-3 saat)	Busbar	

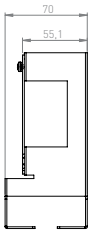
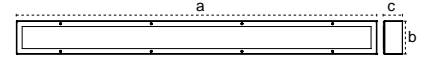

Busbar Aparatı
316387

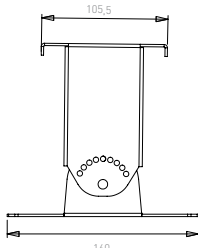

Açı Ayarlı Montaj Aparatı
321804

Kod	Özellikler	Koli Adedi	Fiyat
316387	Etna G2/ Hima G2/ Karpas G3 Busbar Askı Takımı	1	7.30\$
321804	Etna G2/ Hima G2/ Karpas G3 Açı Ayarlı Bağlantı Takımı	1	10.30\$

Endüstriyel Aydınlatmada MAX AİLESİ

INOVALED G3 MAX

- 5 Yıl Garanti
- Alüminyum Gövde
- 150W/18750 lm
- 125lm/W'a Varan Etkinlik Faktörü
- IP66 Toz ve Su Geçirmez
- Temperli Cam
- Açı Ayarlı Montaj İmkanı

LARGO MAX

- 5 Yıl Garanti
- PC Gövde
- 100W/12400 lm
- 132lm/W'a Varan Etkinlik Faktörü
- IP65
- Kolay Montaj

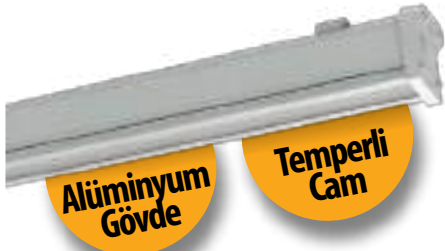

Inovaled G3 Max

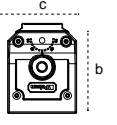
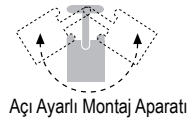

Kod	Güç (W)	Renk Sıcaklığı (K)	Işık Akısı (lm)	Etkinlik Faktörü (lm/W)	Boyutlar (mm)axbxc	Koli Ağırlığı (kg)	Koli Adedi	Fiyat
116580	100	6500	12300	123	910x72x59	10,7	6	116,25\$
116581	120	6500	15000	125	1190x72x59	14,7	6	141,50\$
116582	150	6500	18750	125	1470x72x59	19,7	6	154,25\$



- Özellikler: Alüminyum, Temperli Cam, 3000/4000/6500K, IP66, 50.000h, 5 Yıl
- Opsiyonlar: DALI, Acil Aydınlatma (1-3 saat), Busbar



Largo G2 Max

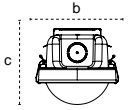

Kod	Güç (W)	Renk Sıcaklığı (K)	Işık Akısı (lm)	Etkinlik Faktörü (lm/W)	Boyutlar (mm)axbxc	Koli Ağırlığı (kg)	Koli Adedi	Fiyat
116063	50	6500	6600	132	1150x80x75	14,7	6	61,20\$
116064	75	6500	9375	125	1150x80x75	14,7	6	79,40\$
116067	100	6500	12400	124	1500x80x75	19,1	6	92,50\$



- Özellikler: PC, Opal Difüzör, 3000/4000/6500K, IP65, 50.000h, 5 Yıl
- Opsiyonlar: DALI, 1-10V, Acil Aydınlatma (1-3 saat), Radar Sensör, Busbar



5
YIL
GARANTİ75-100W
Ø295150-200W
Ø345

Ürün Tanıtım Broşürü

154lm/W'a Varan
Etkinlik Faktörü

Acil Kit

Reflektör
Opsiyonu45°/90°
Lens SeçeneğiDriver
ÜstünlükleriENEC Belgeli
Sürücü100.000 h
Driver Ömrü10kV Dahili
Parafudr

-40°C +55°C



IP67

100-277Vac
Gerilim Dalgalanmalarından Etkilenmez

Castor G3 75W-100W

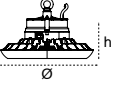

Kod	Tip	Güç (W)	Renk Sıcaklığı (K)	Işık Akısı (lm)	Etkinlik Faktörü (lm/W)	Boyutlar (mm)Øxh	Koli Ağırlığı (kg)	Koli Adedi	Fiyat
114042	90°	75	5700	11550	154	272x180	16,8	6	139,00\$
114043	90°	100	5700	14900	149	272x180	16,8	6	139,00\$

Özellikler	Alüminyum	PC Difüzör	4000/5700/6500K	IP65	62.000h	5 Yıl
Opsiyonlar	DALI	1-10V	Acil Aydınlatma (1-3 saat)	Radar Sensör	Sarkıt	45° / 90° Lens



Castor G3 150W-200W

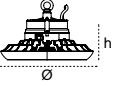

Kod	Tip	Güç (W)	Renk Sıcaklığı (K)	Işık Akısı (lm)	Etkinlik Faktörü (lm/W)	Boyutlar (mm)Øxh	Koli Ağırlığı (kg)	Koli Adedi	Fiyat
114044	90°	150	5700	21900	146	323x186	12,8	4	164,00\$
114045	90°	200	5700	28400	142	323x186	12,8	4	216,00\$

Özellikler	Alüminyum	PC Difüzör	4000/5700/6500K	IP65	62.000h	5 Yıl
Opsiyonlar	DALI	1-10V	Acil Aydınlatma (1-3 saat)	Radar Sensör	Sarkıt	45° / 90° Lens



Monte G2 100W

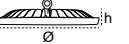

Kod	Güç (W)	Renk Sıcaklığı (K)	Işık Akısı (lm)	Etkinlik Faktörü (lm/W)	Boyutlar (mm)Øxh	Koli Ağırlığı (kg)	Koli Adedi	Fiyat
110569	100	5700	11500	115	272x180	9,6	6	88,00\$

Özellikler	Alüminyum	Temperli Cam	5700K	IP65	90.000h
------------	-----------	--------------	-------	------	---------



Monte G2 150W



Kod	Güç (W)	Renk Sıcaklığı (K)	Işık Akısı (lm)	Etkinlik Faktörü (lm/W)	Boyutlar (mm)Øxh	Koli Ağırlığı (kg)	Koli Adedi	Fiyat
110570	150	5700	18450	123	323x186	11,6	4	113,00\$

Özellikler	Alüminyum	Temperli Cam	5700K	IP65	90.000h
------------	-----------	--------------	-------	------	---------

Kod	Özellikler	Koli Adedi	Fiyat
325718	Castor G2 Busbar Askı Takımı	1	3,90\$
325458	Castor G2 Kamaşma Önleyici Reflektör	1	19,90\$
334981	Castor G3 Açık Ayarlı Braket	1	00,00\$



Zone1, Zone21 ATEX Belgeli Ex-Proof Armatürler



ZONE 1
ZONE 21 II 2G Ex db IIB T6 Gb
II 2D Ex tb IIIC (T85°C) Db

Exta Ex-Proof Etanj Armatür

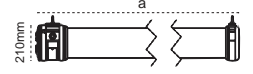

Kod	Güç (W)	Renk Sıcaklığı (K)	Işık Akısı (lm)	Etkinlik Faktörü (lm/W)	Boyutlar (mm)axbxc	Koli Ağırlığı (kg)	Koli Adedi	Fiyat
115871	14	6500	2030	145	471x152x70	3,8	1	646,00\$
115872	26	6500	3692	142	760x152x70	6,5	1	692,00\$
115490	35	6500	4900	140	1320x152x70	10,5	1	739,00\$
115873	50	6500	7000	140	1320x152x70	10,5	1	739,00\$

Özellikler	Alüminyum	PC Difüzör	3000/4000/6500K	IP66	50.000h
Opsiyonlar	DALI	1-10V	Acil Aydınlatma (1-3 saat)	Radar Sensör	



ZONE 1
ZONE 21 II 2G Ex db IIB T6 Gb
II 2D Ex tb IIIC (T85°C) Db

Exta Ex-Proof Yüksek Tavan Armatürü

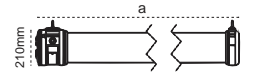

Kod	Güç (W)	Renk Sıcaklığı (K)	Işık Akısı (lm)	Etkinlik Faktörü (lm/W)	Boyutlar (mm)axbxc	Koli Ağırlığı (kg)	Koli Adedi	Fiyat
115874	75	6500	10500	140	1320x152x70	10,5	1	767,00\$
115875	100	6500	13600	136	1620x152x70	13	1	1.015,00\$
115489	150	6500	20400	136	1620x152x70	13	1	1.109,00\$

Özellikler	Alüminyum	PC Difüzör	3000/4000/6500K	IP66	50.000h
Opsiyonlar	DALI	1-10V	Acil Aydınlatma (1-3 saat)	Radar Sensör	



ZONE 1
ZONE 21 II 2G Ex eb db IIB T4-T6 Gb
II 2D Ex tb IIIC (T130°-T85°C) Db

Atarex Ex-Proof Yüksek Tavan Armatürü

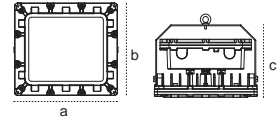

Kod	Güç (W)	Renk Sıcaklığı (K)	Işık Akısı (lm)	Etkinlik Faktörü (lm/W)	Boyutlar (mm)axbxc	Koli Ağırlığı (kg)	Koli Adedi	Fiyat
115866	50	6500	6000	120	342x307x241	15,3	1	1.339,00\$
115867	100	6500	13200	132	342x307x241	15,3	1	1.339,00\$
115868	150	6500	19350	129	342x307x241	15,3	1	1.339,00\$
115869	200	6500	25000	125	342x307x241	15,3	1	1.911,00\$
115870	240	6500	29520	123	342x307x241	15,3	1	2.308,00\$

Özellikler	Alüminyum	Temperli Cam	3000/4000/6500K	IP66	50.000h
Opsiyonlar	DALI	1-10V	Acil Aydınlatma (1-3 saat)	RAL Kod	30° / 60° / 90°



ZONE 1
ZONE 21 II 2G Ex eb db IIB T4-T6 Gb
II 2D Ex tb IIIC (T130°-T85°C) Db

Atarex Ex-Proof Projektör

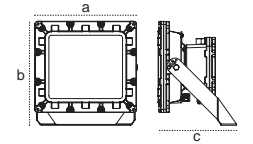

Kod	Güç (W)	Renk Sıcaklığı (K)	Işık Akısı (lm)	Etkinlik Faktörü (lm/W)	Boyutlar (mm)axbxc	Koli Ağırlığı (kg)	Koli Adedi	Fiyat
115486	50	6500	6000	120	342x350x264	15,5	1	1.339,00\$
115865	100	6500	13200	132	342x350x264	15,5	1	1.339,00\$
115864	150	6500	19350	129	342x350x264	15,5	1	1.339,00\$
115863	200	6500	25000	125	342x350x264	15,5	1	1.911,00\$
115487	240	6500	29520	123	342x350x264	15,5	1	2.308,00\$
115780	480	6500	50400	105	438x754x488	24,9	1	4.617,00\$

Özellikler	Alüminyum	Temperli Cam	3000/4000/6500K	IP66	50.000h
Opsiyonlar	DALI	1-10V	Acil Aydınlatma (1-3 saat)	RAL Kod	30° / 60° / 90°



ZONE 1
ZONE 21 II 2G Ex db IIB T6 Gb
II 2D Ex tb IIIC (T85°C) Db

Exta Exit Ex-Proof Acil Yönlendirme ve Aydınlatma Armatürü

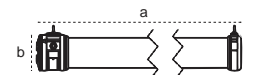

Kod	Güç (W)	Batarya	Şarj Süresi	Renk Sıcaklığı (K)	Işık Akısı (lm)	Etkinlik Faktörü (lm/W)	Boyutlar (mm)axbxc	Koli Ağırlığı (kg)	Koli Adedi	Fiyat
115488	8	3,7V 4500mAh	3h.	6500	480	60	182x465x168	3,8	1	480,00\$

Özellikler	Alüminyum	PC Difüzör	3000/4000/6500K	IP66	50.000h	Acil Aydınlatma (1-3 saat)
-------------------	-----------	------------	-----------------	------	---------	----------------------------





Zone2, Zone22 ATEX Belgeli Ex-Proof Armatürler

Pelsan

● Toz Patlama Koruması: Zone 22 ● Gaz Patlama Koruması: Zone 2



Ausled Ex-Proof Acil Aydınlatma

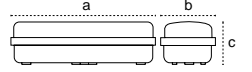

ZONE 2
ZONE 22
II 3G Ex ec IIC T6 Gc
II 3D Ex tc IIIC (T85°C) Dc



Kod	Güç (W)	Batarya	Şarj Süresi	Deşarj Süresi	Işık Akısı (lm)	Renk Sıcaklığı (K)	Etkinlik Faktörü (lm/W)	Boyutlar (mm)axbxc	Koli Ağırlığı (kg)	Koli Adedi	Fiyat
109710	15	3,7V 4500mAh	24h	3h	1500	6500	100	350x117x76	5,5	6	108,50\$

Özellikler: PC, PC Difüzör, 3000/400/6500K, IP65, 50.000h



Largo LED Tube Ex-Proof Etanj

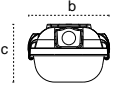

ZONE 2
ZONE 22
II 3G Ex ec IIC T6 Gc
II 3D Ex tc IIIC (T85°C) Dc



Kod	Güç (W)	Duy	Boyutlar (mm)axbxc	Koli Ağırlığı (kg)	Koli Adedi	Fiyat
111402	1x9 max	1xG13	670x85x125	11	6	93,00\$
111404	2x9 max	2xG13	670x85x125	12,8	6	98,00\$
111405	1x18 max	1xG13	1280x85x125	17	6	117,00\$
111406	2x18 max	2xG13	1280x85x125	18,5	6	119,00\$

Özellikler: GRP, PC Difüzör, IP65, 50.000h



Largo LED Ex-Proof Etanj

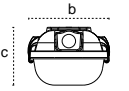

ZONE 2
ZONE 22
II 3G Ex ec IIC T6 Gc
II 3D Ex tc IIIC (T85°C) Dc



Kod	Tip	Güç (W)	Renk Sıcaklığı (K)	Işık Akısı (lm)	Etkinlik Faktörü (lm/W)	Boyutlar (mm)axbxc	Koli Ağırlığı (kg)	Koli Adedi	Fiyat
108458	Opal	25	6500	2750	110	670x85x125	12,8	6	213,50\$
108459	Opal	45	6500	4950	110	1280x85x125	18,5	6	229,25\$

Özellikler: GRP, PC Difüzör, 3000/400/6500K, IP65, 50.000h

Opsiyonlar: Acil Aydınlatma (1-3 saat)



Piroliz Ex-Proof Kanopi Armatürü

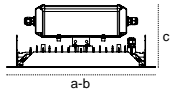

ZONE 2
ZONE 22
II 3G Ex ec IIC T5 Gc
II 3D Ex tc IIIC (T95°C) Dc



Kod	Güç (W)	Renk Sıcaklığı (K)	Işık Akısı (lm)	Etkinlik Faktörü (lm/W)	Boyutlar (mm)axbxc	Koli Ağırlığı (kg)	Koli Adedi	Fiyat
111376	50	6500	8250	165	342x342x175	8	1	398,00\$
111375	75	6500	12000	160	342x342x175	8	1	450,00\$
111374	100	6500	15500	155	342x342x175	8	1	502,00\$
111382	125	6500	19000	152	342x342x175	8	1	553,00\$
111373	150	6500	22500	150	342x342x175	8	1	604,00\$
111056	200	6500	28600	143	342x342x175	8	1	667,00\$

Özellikler: Alüminyum, Temperli Cam, 4000/5700/6500K, IP66, 50.000h

Opsiyonlar: 30° / 60° / 90°



Zone2, Zone22 ATEX Belgeli Ex-Proof Armatürler

Pelsan

● Toz Patlama Koruması: Zone 22 ● Gaz Patlama Koruması: Zone 2



ZONE 2
ZONE 22
II 3G Ex ec IIC T5 Gc
II 3D Ex tc IIIC (T95°C) DC



Nairo Ex-Proof Projektör

Kod	Güç (W)	Renk Sıcaklığı (K)	Işık Akısı (lm)	Etkinlik Faktörü (lm/W)	Boyutlar (mm)axbxc	Koli Ağırlığı (kg)	Koli Adedi	Fiyat
111372	50	6500	8250	165	342x342x158	8	1	398,00\$
111371	75	6500	12000	160	342x342x158	8	1	450,00\$
111370	100	6500	15500	155	342x342x158	8	1	502,00\$
111369	125	6500	19000	152	342x342x158	8	1	553,00\$
111368	150	6500	22500	150	342x342x158	8	1	604,00\$
111055	200	6500	28600	143	342x342x158	8	1	667,00\$

Özellikler	Alüminyum	Temperli Cam	4000/5700/6500K	IP66	50.000h
Opsiyonlar	30° / 60° / 90°				

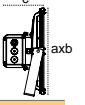

ZONE 2
ZONE 22
II 3G Ex ec IIC T5 Gc
II 3D Ex tc IIIC (T95°C) DC



Sia Ex-Proof Yüksek Tavan Armatürü

Kod	Güç (W)	Renk Sıcaklığı (K)	Işık Akısı (lm)	Etkinlik Faktörü (lm/W)	Boyutlar (mm)axbxc	Koli Ağırlığı (kg)	Koli Adedi	Fiyat
111381	50	6500	8250	165	342x342x175	8	1	398,00\$
111380	75	6500	12000	160	342x342x175	8	1	450,00\$
111379	100	6500	15500	155	342x342x175	8	1	502,00\$
111378	125	6500	19000	152	342x342x175	8	1	553,00\$
111377	150	6500	22500	150	342x342x175	8	1	604,00\$
111053	200	6500	28600	143	342x342x175	8	1	667,00\$

Özellikler	Alüminyum	Temperli Cam	4000/5700/6500K	IP66	50.000h
Opsiyonlar	30° / 60° / 90°				

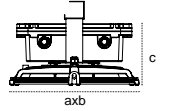

ZONE 2
ZONE 22
II 3G Ex ec IIC T5 Gc
II 3D Ex tc IIIC (T95°C) DC



Elit Lirad Ex-Proof Projektör

Kod	Güç (W)	Renk Sıcaklığı (K)	Işık Akısı (lm)	Etkinlik Faktörü (lm/W)	Boyutlar (mm)axbxc	Koli Ağırlığı (kg)	Koli Adedi	Fiyat
109707	50	6500	7000	140	295x200x175	18	6	258,00\$

Özellikler	GRP	Temperli Cam	4000/5700/6500K	IP65	50.000h
Opsiyonlar	30° / 60° / 90°				

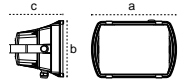

ZONE 2
ZONE 22
II 3G Ex ec IIC T5 Gc
II 3D Ex tc IIIC (T95°C) DC



Nairo SL Ex-Proof Yol-Cadde Armatürü

Kod	Güç (W)	Renk Sıcaklığı (K)	Işık Akısı (lm)	Etkinlik Faktörü (lm/W)	Boyutlar (mm)axbxc	Konsol Girişi (mm)	Koli Ağırlığı (kg)	Koli Adedi	Fiyat
111365	100	4000	15200	152	352x352x152	42-60	8	1	518,00\$
111364	125	4000	18625	149	352x352x152	42-60	8	1	569,00\$

Özellikler	Alüminyum	Temperli Cam	4000/5700/6500K	IP66	50.000h
------------	-----------	--------------	-----------------	------	---------

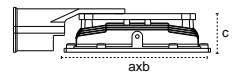

Uzun Ömürlü, Yüksek Verimli...

Gaziantep Kalesi LED Aydınlatması, Pelsan Aydınlatma M. Reşit Göğüş tarafından yapılmıştır.



IP66 Toz ve Su Almaz



Temperli Cam



IK08 Darbe Dayanımı



Alüminyum Gövde

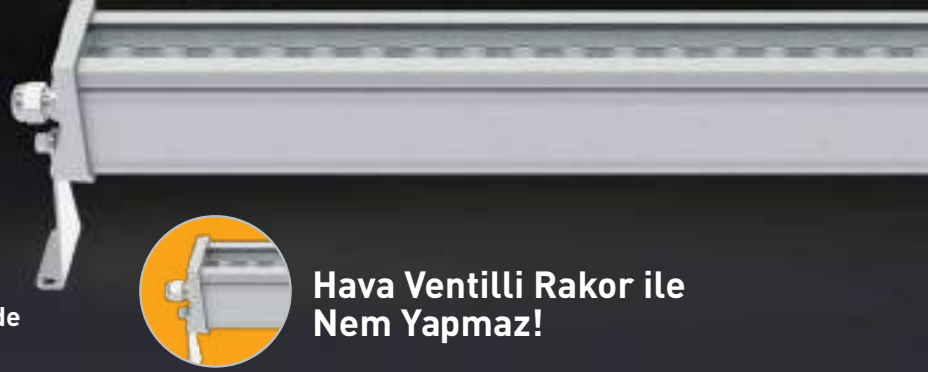

Hava Ventilli Rakor ile Nem Yapmaz!

Inoaled G3 IP66

Sıva Üstü Wallwasher

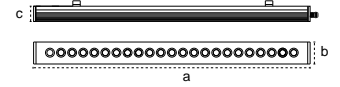

Kod	Tip	Güç (W)	Renk Sıcaklığı (K)	Işık Akısı (lm)	Etkinlik Faktörü (lm/W)	Boyutlar (mm)axbxc	Koli Ağırlığı (kg)	Koli Adedi	Fiyat
116590	45+20°	14	3000	1540	110	327x75x63	5,8	6	44,90\$
116591	45+20°	14	4000	1540	110	327x75x63	5,8	6	44,90\$
116592	45+20°	14	6500	1540	110	327x75x63	5,8	6	44,90\$

Özellikler	Alüminyum	Temperli Cam	4000/5700/6500K	IP66	50.000h
Opsiyonlar	Amber Renk	Yeşil Renk	Kırmızı Renk	Mavi Renk	



Inoaled G3 IP66

Sıva Üstü Wallwasher

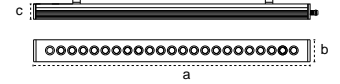

Kod	Tip	Güç (W)	Renk Sıcaklığı (K)	Işık Akısı (lm)	Etkinlik Faktörü (lm/W)	Boyutlar (mm)axbxc	Koli Ağırlığı (kg)	Koli Adedi	Fiyat
116605	45+20°	28	3000	3080	110	622x75x63	8,5	6	72,10\$
116604	45+20°	28	4000	3080	110	622x75x63	8,5	6	72,10\$
116603	45+20°	28	6500	3080	110	622x75x63	8,5	6	72,10\$

Özellikler	Alüminyum	Temperli Cam	4000/5700/6500K	IP66	50.000h
Opsiyonlar	Amber Renk	Yeşil Renk	Kırmızı Renk	Mavi Renk	



Inoaled G3 IP66

Sıva Üstü Wallwasher

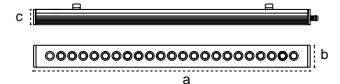

Kod	Tip	Güç (W)	Renk Sıcaklığı (K)	Işık Akısı (lm)	Etkinlik Faktörü (lm/W)	Boyutlar (mm)axbxc	Koli Ağırlığı (kg)	Koli Adedi	Fiyat
116613	45+20°	42	3000	4620	110	917x75x63	10,6	6	112,80\$
116612	45+20°	42	4000	4620	110	917x75x63	10,6	6	112,80\$
116611	45+20°	42	6500	4620	110	917x75x63	10,6	6	112,80\$

Özellikler	Alüminyum	Temperli Cam	4000/5700/6500K	IP66	50.000h
Opsiyonlar	Amber Renk	Yeşil Renk	Kırmızı Renk	Mavi Renk	



Pelsan

CRUZO G2

YÜKSEK GÜÇLÜ PROJEKTÖR SERİSİ



CB

EAC



1800W



246600 lm



144 lm/W



HD Yayın



Flicker Free



CRI90

**DALI
DMX RDM**

YENİ

Yüksek Güçlü Projektörler

Pelsan

Cruzo G2

Cruzo G2

*CB, *ENEC belgeli



ürün broşürü



1800W
LED Projektör



Driver Üstünlükleri



ENEC Belgeli Sürücü



100.000 h Driver Ömrü



10kV Dahili Parafudr



-40°C +55°C



IP67



100-277Vac

Gerilim Dalgalanmalarından Etkilenmez

Cruzo IP66 500-600W Projektör

10kV Dahili Parafudr

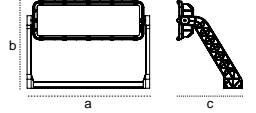

Kod	Güç (W)	Renk Sıcaklığı (K)	Işık Akısı (lm)	Etkinlik Faktörü (lm/W)	Boyutlar (mm)axbxc	Koli Ağırlığı (kg)	Koli Adedi	Fiyat
115898	500	5700	70000	140	716x387x319	18	1	903,00\$
115975	600	5700	83400	139	716x387x319	18	1	903,00\$



Özellikler



Alüminyum



Temperli Cam



4000/5700/6500K



IP66



62.000h

Opsiyonlar



DALI



1-10V



Step DIM



Elektriksel Sınıf I/II



10° / 30° / 60° / 90° Asimetrik

Cruzo IP66 800-1200W Projektör

10kV Dahili Parafudr

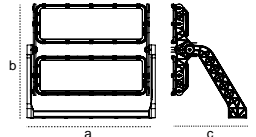

Kod	Güç (W)	Renk Sıcaklığı (K)	Işık Akısı (lm)	Etkinlik Faktörü (lm/W)	Boyutlar (mm)axbxc	Koli Ağırlığı (kg)	Koli Adedi	Fiyat
115976	800	5700	128000	160	816x723x479	29	1	1.545,00\$
115977	900	5700	140400	156	816x723x479	29	1	1.545,00\$
115899	1000	5700	150000	150	816x723x479	29	1	1.545,00\$
115978	1200	5700	175200	146	816x723x479	29	1	2.050,00\$



Özellikler



Alüminyum



Temperli Cam



4000/5700/6500K



IP66



62.000h

Opsiyonlar



DALI



1-10V



Step DIM



Elektriksel Sınıf I/II



10° / 30° / 60° / 90° Asimetrik

Cruzo IP66 1500-1800W Projektör

10kV Dahili Parafudr

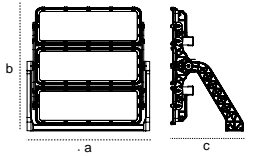

Kod	Güç (W)	Renk Sıcaklığı (K)	Işık Akısı (lm)	Etkinlik Faktörü (lm/W)	Boyutlar (mm)axbxc	Koli Ağırlığı (kg)	Koli Adedi	Fiyat
115900	1500	5700	222000	148	816x821x479	38	1	3.325,00\$
115901	1800	5700	250200	139	816x821x479	38	1	3.325,00\$



Özellikler



Alüminyum



Temperli Cam



4000/5700/6500K



IP66



62.000h

Opsiyonlar



DALI



1-10V



Step DIM



Elektriksel Sınıf I/II



Marin Boya



30° / 60° / 90° Asimetrik

* CB ve ENEC belgeleri 1200W'a kadar (Dahil) geçerlidir.

* 1800W'a kadar ENEC ve ENEC+ başvuruları yapılmıştır.



Ria Med G2

Şimdi 200W

26000 lm



Driver
Üstünlükleri



ENEC Belgeli
Sürücü



100.000 h
Driver Ömrü



10kV Dahili
Parafudr



-40°C +55°C



IP67



100-277Vac
Gerilim Dalgalanmalarından Etkilenmez



Ria Med G2 IP66

60-200W Projektör

10kV Dahili
Parafudr

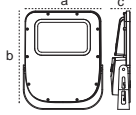

Kod	Güç (W)	Renk Sıcaklığı (K)	Işık Akısı (lm)	Etkinlik Faktörü (lm/W)	Boyutlar (mm)axbxc	Koli Ağırlığı (kg)	Koli Adedi	Fiyat
111788	60	6500	8820	147	274x340x66	15,05	4	126,00\$
111785	80	6500	11360	142	274x340x66	15,05	4	160,00\$
111660	100	6500	13400	134	274x340x66	15,05	4	160,00\$
111666	150	6500	20700	138	274x340x66	15,05	4	187,00\$
116136	200	6500	26000	130	274x340x66	15,05	4	300,00\$



Özellikler



Alüminyum



Temperli Cam



3000/4000/6500K



IP66



62.000h



5 Yıl



Opsiyonlar



DALI



1-10V



Step DIM



Elektriksel Sınıf I/II



Marin Boya



30° / 60° / 90° Asimetrik**

**Asimetrik Lens 50 - 100 W arasında sunulmaktadır.



Ria IP66 Simetrik

200-400W Projektör

10kV Dahili
Parafudr

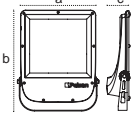

Kod	Güç (W)	Renk Sıcaklığı (K)	Işık Akısı (lm)	Etkinlik Faktörü (lm/W)	Boyutlar (mm)axbxc	Koli Ağırlığı (kg)	Koli Adedi	Fiyat
115918	200	6500	30800	154	400x418x100	6	1	410,00\$
115919	250	6500	36500	146	400x418x100	6	1	440,00\$
115920	300	6500	42600	142	400x418x100	6	1	480,00\$
115921	400	6500	60800	152	400x418x100	6	1	555,00\$



Özellikler



Alüminyum



Temperli Cam



3000/4000/6500K



IP66



62.000h



5 Yıl



Opsiyonlar



DALI



1-10V



Step DIM



Elektriksel Sınıf I/II



Marin Boya



30° / 60° / 90° Asimetrik**

**Asimetrik Lens 180-300W arasında sunulmaktadır.



Ria IP66 Asimetrik

200-300W Projektör

10kV Dahili
Parafudr

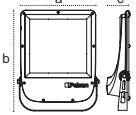

Kod	Güç (W)	Renk Sıcaklığı (K)	Işık Akısı (lm)	Etkinlik Faktörü (lm/W)	Boyutlar (mm)axbxc	Koli Ağırlığı (kg)	Koli Adedi	Fiyat
115922	200	6500	30800	154	400x418x100	6	1	410,00\$
115923	250	6500	36500	146	400x418x100	6	1	440,00\$
115924	300	6500	42600	142	400x418x100	6	1	480,00\$



Özellikler



Alüminyum



Temperli Cam



3000/4000/6500K



IP66



62.000h



5 Yıl



Opsiyonlar



DALI



1-10V



Step DIM



Elektriksel Sınıf I/II



Marin Boya



30° / 60° / 90° Asimetrik



Tartışmasız **EN İYİSİ** Lecto



Geniş PCB Alanı ile
Etkin Isı Tahliyesi



10kV Dahili Parafudr ile
Gerilim Dalgalarına karşı
Güçlü Koruma



Filtre Devreleri ile Gerilim
Dalgalanmalarına karşı
Yüksek Direnc



Uzun Ömürlü



Daha fazla akım dağıtıcı elemanı
(MOSFET) ile elektronik sürücü
üzzerinde **Minimum Stres,
Maksimum Ömür.**



1 Hava Ventili
ile Nem
Yapmaz



2 360°
Döner
Konsol



3 Metal
Rakor



4 Alüminyum
Enjeksiyon
Gövde



Lecto Max 300-500W Projektör

**10kV Dahili
Parafudr**

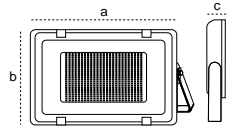

Kod	Güç (W)	Renk Sıcaklığı (K)	Işık Akısı (lm)	Etkinlik Faktörü (lm/W)	Boyutlar (mm)axbxc	Koli Ağırlığı (kg)	Koli Adedi	Fiyat
114120	300	5000	30000	100	470x335x45	17	4	226,00\$
115485	400	5000	40000	100	550x395x60	6,7	1	310,00\$
115484	500	5000	50000	100	605x460x65	10,5	1	518,00\$

Özellikler  Alüminyum  Temperli Cam  5000K  IP65  30.000h

Sterio IP66 250-450W Projektör

**5kV Dahili
Parafudr**

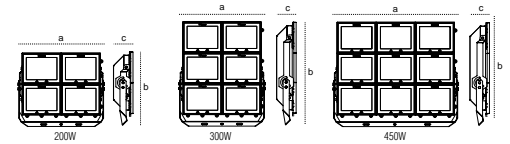

Kod	Güç (W)	Renk Sıcaklığı (K)	Işık Akısı (lm)	Etkinlik Faktörü (lm/W)	Boyutlar (mm)axbxc	Koli Ağırlığı (kg)	Koli Adedi	Fiyat
109536	200	5700	20000	100	415x360x85	6	1	245,00\$
109537	300	5700	30000	100	415x540x85	8	1	382,00\$
109538	450	5700	45000	100	795x390x85	11	1	506,00\$

Özellikler  Alüminyum  Temperli Cam  5700K  IP66  30.000h

Opsiyonlar  Marin Boya

Sınıfının **EN VERİMLİSİ** Lecto

131lm/W'a
Varan Verimlilik



200W

150W

100W

50W



Lecto G2 50W

Projektör

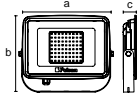

Kod	Güç (W)	Renk Sıcaklığı (K)	Işık Akısı (lm)	Etkinlik Faktörü (lm/W)	Boyutlar (mm)axbxc	Koli Ağırlığı (kg)	Koli Adedi	Fiyat
116003	50	3000	6550	131	220x176x30	16,5	20	26,00\$
115747	50	5000	6550	131	220x176x30	16,5	20	26,00\$



Özellikler



Lecto G2 100W

Projektör

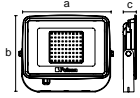

Kod	Güç (W)	Renk Sıcaklığı (K)	Işık Akısı (lm)	Etkinlik Faktörü (lm/W)	Boyutlar (mm)axbxc	Koli Ağırlığı (kg)	Koli Adedi	Fiyat
116004	100	3000	12800	128	257x217x30	14,5	12	55,00\$
115748	100	5000	12800	128	257x217x30	14,5	12	55,00\$



Özellikler



Lecto G2 150W

Projektör

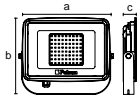

Kod	Güç (W)	Renk Sıcaklığı (K)	Işık Akısı (lm)	Etkinlik Faktörü (lm/W)	Boyutlar (mm)axbxc	Koli Ağırlığı (kg)	Koli Adedi	Fiyat
116005	150	3000	18900	126	313x247x30	16,5	10	97,00\$
115818	150	5000	18900	126	313x247x30	16,5	10	97,00\$



Özellikler



Lecto G2 200W

Projektör

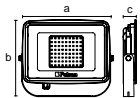

Kod	Güç (W)	Renk Sıcaklığı (K)	Işık Akısı (lm)	Etkinlik Faktörü (lm/W)	Boyutlar (mm)axbxc	Koli Ağırlığı (kg)	Koli Adedi	Fiyat
116006	200	3000	25000	125	375x302x34	15,5	6	136,00\$
115819	200	5000	25000	125	375x302x34	15,5	6	136,00\$



Özellikler



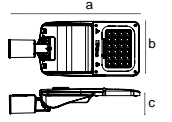

Yeni Ürün



Rio XXS

 10KV Dahili Parafudr

Kod	Güç (W)	Renk Sıcaklığı (K)	Işık Akısı (lm)	Etkinlik Faktörü (lm/W)	Boyutlar (mm)axbxc	Konsol Girişi	Koli Ağırlığı (kg)	Koli Adedi	Fiyat
115610	35	4000	5600	160	178x525x120	42-60	3,3	1	156,50\$
115611	50	4000	7700	154	178x525x120	42-60	3,3	1	156,50\$
115612	60	4000	8880	148	178x525x120	42-60	3,3	1	156,50\$
116421	75	4000	11250	150	178x525x120	42-60	3,3	1	175,00\$
116422	100	4000	14000	140	178x525x120	42-60	3,3	1	175,00\$

Özellikler	Alüminyum	Temperli Cam	3000/4000/6500K	IP66	62.000h		
Opsiyonlar	DALI	1-10V	Step DIM	Nema Soket	Zhaga Soket	Elektriksel Sınıf I/II	Marin Boya

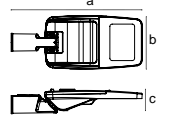

165lm/W'a
Varan Verimlilik



Rio Xs G3

 10KV Dahili Parafudr

Kod	Güç (W)	Renk Sıcaklığı (K)	Işık Akısı (lm)	Etkinlik Faktörü (lm/W)	Boyutlar (mm)axbxc	Konsol Girişi	Koli Ağırlığı (kg)	Koli Adedi	Fiyat
115994	50	4000	8250	165	567x232x106	42-60	3,5	1	175,00\$
115995	60	4000	9900	165	567x232x106	42-60	3,5	1	175,00\$
115996	80	4000	11440	143	567x232x106	42-60	3,5	1	197,50\$
115997	100	4000	15000	150	567x232x106	42-60	3,5	1	197,50\$
116403	125	4000	18625	149	567x232x106	42-60	3,5	1	250,00\$
116405	150	4000	20550	137	567x232x106	42-60	3,5	1	250,00\$

Özellikler	Alüminyum	Temperli Cam	3000/4000/6500K	IP66	62.000h	5 Yıl	
Opsiyonlar	DALI	1-10V	Step DIM	Nema Soket	Zhaga Soket	Elektriksel Sınıf I/II	Marin Boya

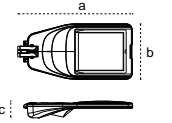

163lm/W'a
Varan Verimlilik



Rio S G2 IP66

 10KV Dahili Parafudr

Kod	Güç (W)	Renk Sıcaklığı (K)	Işık Akısı (lm)	Etkinlik Faktörü (lm/W)	Boyutlar (mm)axbxc	Konsol Girişi	Koli Ağırlığı (kg)	Koli Adedi	Fiyat
115117	80	4000	13040	163	476x280x111	42-60	6,1	1	317,00\$
115119	100	4000	15000	150	476x280x111	42-60	6,1	1	317,00\$
115141	125	4000	18375	147	476x280x111	42-60	6,1	1	327,00\$
115142	150	4000	21450	143	476x280x111	42-60	6,1	1	327,00\$
117090	200	4000	26800	134	476x280x111	42-60	6,1	1	390,00\$

Özellikler	Alüminyum	Temperli Cam	3000/4000/6500K	IP66	62.000h	5 Yıl	
Opsiyonlar	DALI	1-10V	Step DIM	Nema Soket	Zhaga Soket	Elektriksel Sınıf I/II	Marin Boya

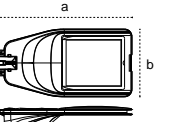

160lm/W'a
Varan Verimlilik



Rio M G2 IP66

 10KV Dahili Parafudr

Kod	Güç (W)	Renk Sıcaklığı (K)	Işık Akısı (lm)	Etkinlik Faktörü (lm/W)	Boyutlar (mm)axbxc	Konsol Girişi	Koli Ağırlığı (kg)	Koli Adedi	Fiyat
115125	180	4000	28800	160	616x330x124	42-60	7,5	1	450,00\$
115126	200	4000	31600	158	616x330x124	42-60	7,5	1	450,00\$

Özellikler	Alüminyum	Temperli Cam	3000/4000/6500K	IP66	62.000h	5 Yıl	
Opsiyonlar	DALI	1-10V	Step DIM	Nema Soket	Zhaga Soket	Elektriksel Sınıf I/II	Marin Boya

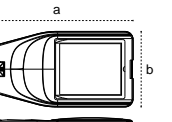

145lm/W'a
Varan Verimlilik



Rio L IP66

 10KV Dahili Parafudr

Kod	Güç (W)	Renk Sıcaklığı (K)	Işık Akısı (lm)	Etkinlik Faktörü (lm/W)	Boyutlar (mm)axbxc	Konsol Girişi	Koli Ağırlığı (kg)	Koli Adedi	Fiyat
110784	240	4000	34800	145	727x370x131	42-60	10,1	1	608,70\$
110785	270	4000	38610	143	727x370x131	42-60	10,1	1	608,70\$
110786	300	4000	42000	140	727x370x131	42-60	10,1	1	608,70\$

Özellikler	Alüminyum	Temperli Cam	3000/4000/6500K	IP66	62.000h	5 Yıl	
Opsiyonlar	DALI	1-10V	Step DIM	Nema Soket	Zhaga Soket	Elektriksel Sınıf I/II	Marin Boya



147lm/W'a
Varan Verimlilik



Doka G2 IP66

10kV Dahili Parafudr

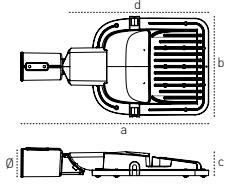

Kod	Güç (W)	Renk Sıcaklığı (K)	Işık Akısı (lm)	Etkinlik Faktörü (lm/W)	Boyutlar (mm)axbxcxd	Konsol Girişi	Koli Ağırlığı (kg)	Koli Adedi	Fiyat
115410	60	4000	8820	147	362x268x65x316	42-60	11,8	4	151,00\$
115412	80	4000	11360	142	362x268x65x316	42-60	11,8	4	165,00\$
115414	100	4000	13800	138	362x268x65x316	42-60	11,8	4	165,00\$
115416	150	4000	19050	127	362x268x65x316	42-60	11,8	4	215,00\$
116241	200	4000	26000	130	362x268x65x316	42-60	11,8	4	330,00\$

Özellikler	Alüminyum	Temperli Cam	3000/4000/6500K	IP66	62.000h	5 Yıl
Opsiyonlar	DALI	1-10V	Step DIM	Elektriksel Sınıf I/II	Marin Boya	



Ekonomik Çözüm



Berlin

6kV Dahili Parafudr

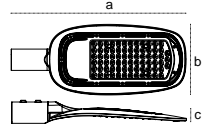

Kod	Güç (W)	Renk Sıcaklığı (K)	Işık Akısı (lm)	Etkinlik Faktörü (lm/W)	Boyutlar (mm)axbxc	Konsol Girişi	Koli Ağırlığı (kg)	Koli Adedi	Fiyat
113622	60	5000	6600	110	409x165x54	42	10	10	71,70\$
114994	80	5000	8400	105	409x165x54	42	10,2	10	101,80\$
113623	100	5000	10500	105	498x201x73	42-60	10,5	6	119,10\$
109856	150	5000	15750	105	571x248x76	42-60	13,8	6	172,20\$

Özellikler	Alüminyum	PC Difüzör	5000K	IP65	30.000h
------------	-----------	------------	-------	------	---------

Denize kıyısı bulanan bölgeler ve marinalar için özel tasarlandı.



ASLA PASLANMAZ!

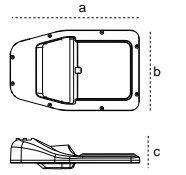

Madrid

Kod	Güç (W)	Renk Sıcaklığı (K)	Işık Akısı (lm)	Etkinlik Faktörü (lm/W)	Boyutlar (mm)axbxc	Konsol Girişi	Koli Ağırlığı (kg)	Koli Adedi	Fiyat
109841	20	4000	2760	138	324x201x75	42-48	8,7	6	62,25\$
108494	33	4000	4257	129	324x201x75	42-48	8,7	6	64,50\$
109877	40	4000	5840	146	324x201x75	42-48	8,7	6	80,00\$

Özellikler	PC	PC Difüzör	3000/4000/6500K	IP65	50.000h
------------	----	------------	-----------------	------	---------



146lm/W'a
Varan Verimlilik



ATEX Belgeleri

ATEX Belgeli Pelsan Exproof armatürler, tehlikeli gaz ve toz maddelerinin bulunduğu, patlama riski olan ortamlarda güvenle kullanılabilir.

Zone2, Zone22



ATEX
Large Ex-Proof



ATEX
Elit Lirad Ex-Proof



ATEX
Ausled-Rausled
Ex-Proof



ATEX
Sia/Nairo/Piroliz
Ex-Proof

Zone1, Zone21



ATEX
Atarex Yüksek Tavan
Ex-Proof



ATEX
Atarex Projektör
Ex-Proof



ATEX
Extax Ex-Proof

TSE Belgeleri



Yol ve Caddede Armatürleri



Projektörler



Genel Amaçlı Sabit Armatürler



Sıva Altı Armatürler

ENEC Belgeleri

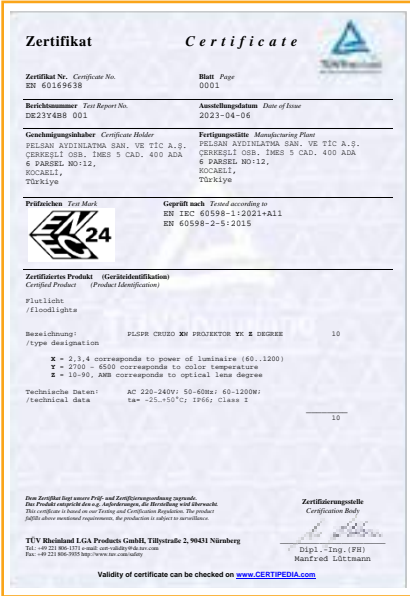

Projektörler



Projektörler



Yol ve Caddede Armatürleri



EAC Belgeleri



Ofis Armatürler



Downlight



Acil Aydınlatma Armatürleri

Acil Aydınlatma ve
Yönlendirme Armatürler

Etanj Armatürler



Yüksek Tavan Armatürler



Projektörler



Yol ve Cadde Armatürleri



MÜZEYYEN ERKUL BİLİM MERKEZİ - GAZİANTEP



SAMSUN MÜZESİ - SAMSUN



DMX - GAZİANTEP



DMX - ÖZBEKİSTAN



KAPİTAL BANK - AZERBAYCAN



SEA BREZE - AZERBAYCAN



ATATÜRK HALK KÜTÜPHANESİ - İZMİR





recta

art and light



yeni
Mimari Aydınlatma
Markamız



Fiyat Listesi için;





ŞOK FİYAT
505,00 \$

 **Amos**
Sayfa 08

Park & Bahçe Armatürü

AMOS

Park & Bahçe Armatürleri
Fiyat Listesi için
Kataloğun arka yüzünü çeviriniz.



Park & Bahçe Armatürleri

FİYAT LİSTESİ

2025/1

Paleo
Sayfa 07



Güncel ürün bilgisi ve belgeleri için www.pelsan.com.tr'yi ziyaret ediniz.

www.pelsan.com.tr
info@pelsan.com.tr | export@pelsan.com.tr

Fiyatlara K.D.V. dahil değildir. Pelsan Aydınlatma gerekli koşullarda fiyat ve ürün değiştirme hakkını saklı tutar.

MODERN HATLI DİREKLER

 **Olimpos Med**
Sayfa 07



(206074)

(206075)

(206073)

(206072)

KLASİK
DİREKLER
LAGINA



2025/1

İÇİNDEKİLER



06

Luma



06

Mesaled

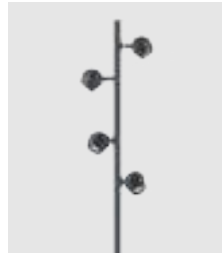

07

Paleo



07

Olimpos Med



08

Amos



08

Troya Elegance



08

Gordion



08

Troya G2



09

Larissa



09

Terna



09

Pila



09

Luzon



09

Dara



09

Milas



09

Milas

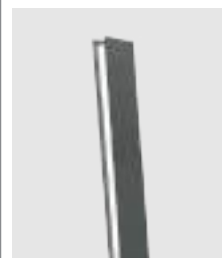

10

Cauna

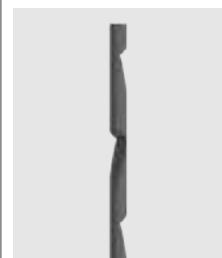

10

Sidyma



10

Limra



10

Petra



10

Evaled

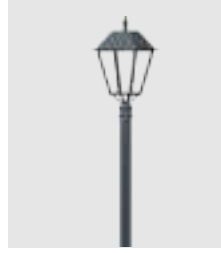

11

Lorna

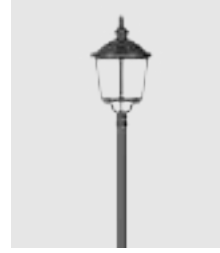

11

Gamon



11

Kedria



11

Lagina



11

Teos



12

Palmira



12

Olimpos

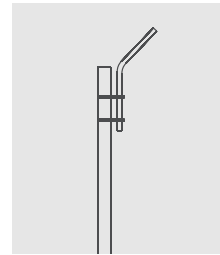

13

Direkler



14

Bolardlar



17

Set Üstü
Armatürler



18

Dış Mekan
Aplikler

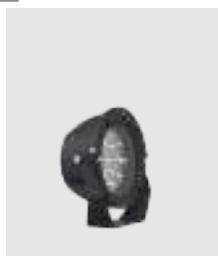

21

Çim Spotları ve
Duvar Gömme

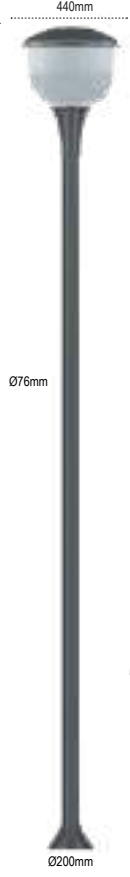

Maksimum Görsel Konfor

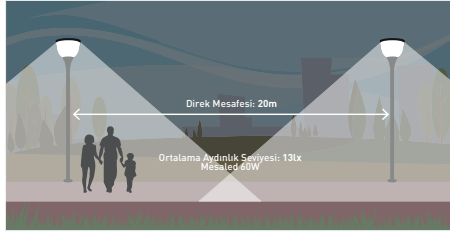

Yeni Ürün



Luma

Kod	Güç (W)	Renk Sıcaklığı (K)	Direk Boyutu (mm)	Fiyat
212514	65	4000	3500	440,00\$

Özellikler IP54

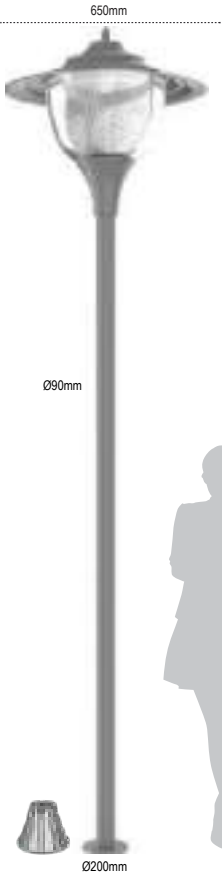

Kamaşma kontrollü özel difüzör



Özel prizmatik difüzör



Kamaşma yapmayan optik dizayn



Yüksek ışık geçirgenliği



Kamaşma Önleyici Özel Difüzörü ile Görsel Konfor Sağlar

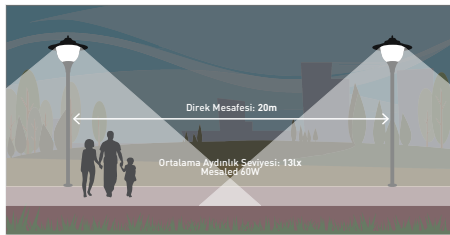

Mesaled

Kod	Güç (W)	Renk Sıcaklığı (K)	Direk Boyutu (mm)	Fiyat
108609	30	4000	3500	363,00\$
108608	60	4000	3500	400,00\$

Özellikler IP54





Yeni Ürün

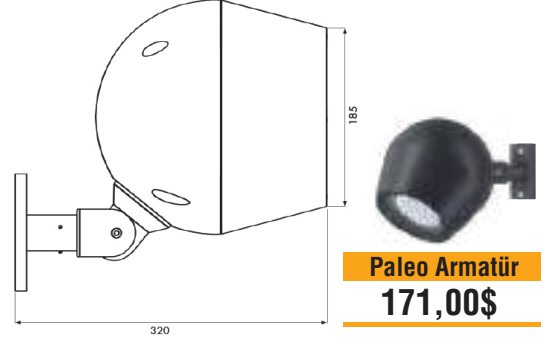

Paleo Armatur
171,00\$

4m Direk
220,00\$

6m Direk
330,00\$

Paleo

Kod	Güç (W)	Renk Sıcaklığı (K)	Direk Boyutu (mm)	Fiyat
212317	4x30	4000	4000	897,00\$
212318	5x30	4000	6000	1.255,00\$

Özellikler	 Alüminyum	 Temperli Cam	 Galvaniz Direk	 IP65
Opsiyonlar	 DALI	 1-10V	 Marin Boya	
	 Direk Yüksekliği: 3000 - 6000 mm			

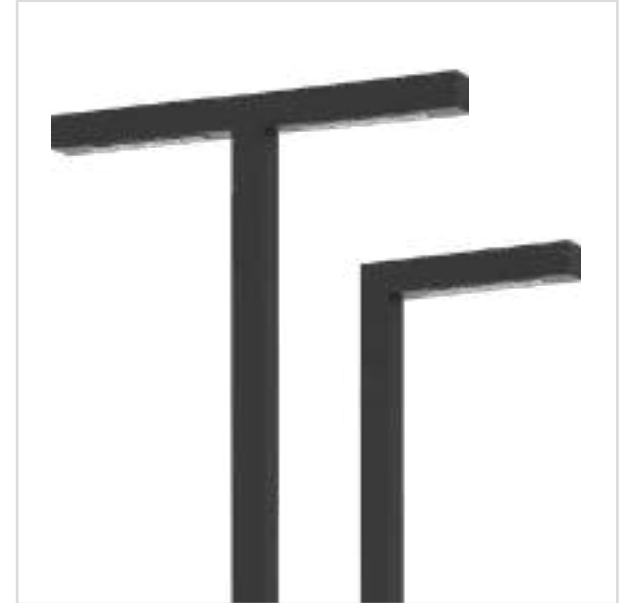
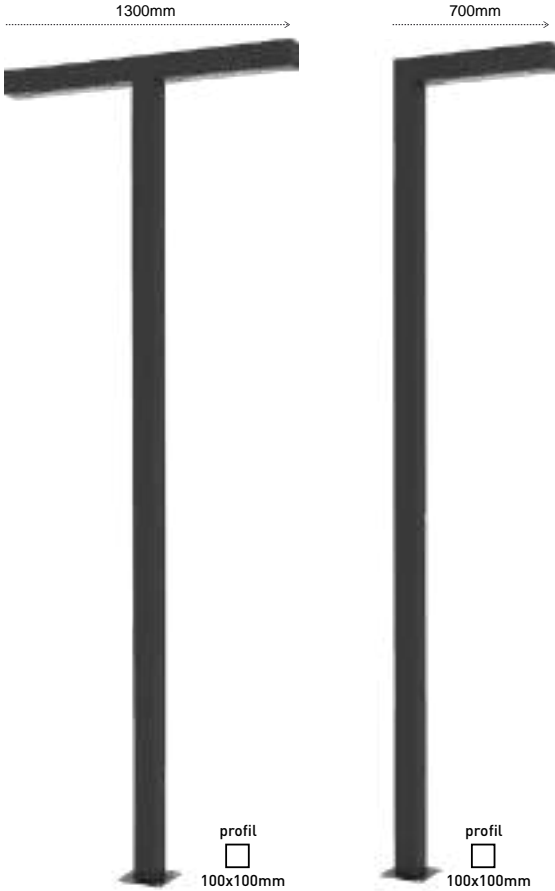

Olimpos Med

Kod	Güç (W)	Renk Sıcaklığı (K)	Direk Boyutu (mm)	Fiyat
206073	1x30	4000	3000	267,00\$
206072	2x30	4000	3000	364,50\$

Özellikler	 Alüminyum	 IP65
Opsiyon	 Direk Yüksekliği: 3000 - 6000 mm	

* Özel ölçüler için satış ekibimiz ile iletişime geçiniz.

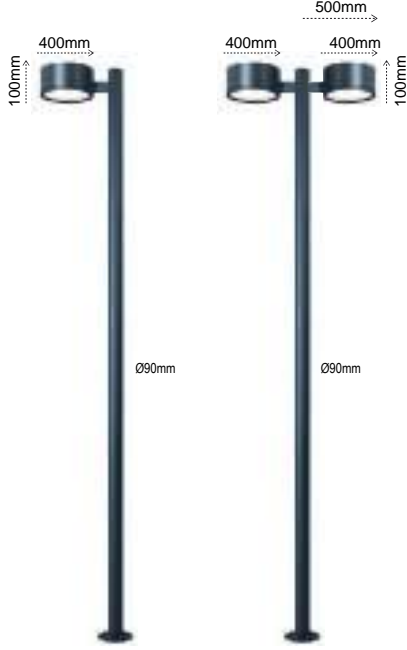

Amos

Yeni Ürün

Kod	Güç (W)	Renk Sıcaklığı (K)	Direk Boyutu (mm)	Fiyat
212315	40	4000	4000	350,00\$
212316	2x40	4000	4000	505,00\$

- Özellikler** → Alüminyum, Temperli Cam, Galvaniz Direk, IP54
- Opsiyonlar** → DALI, 1-10V, Marin Boya
- Direk Yüksekliği: 3000 - 6000 mm



Troya Elegance

Kod	Güç (W)	Renk Sıcaklığı (K)	Direk Boyutu (mm)	Fiyat
209935	30	4000	4500	475,00\$
209938	40	4000	4500	475,00\$
209941	50	4000	4500	475,00\$
209944	60	4000	4500	475,00\$

- Özellikler** → Alüminyum, Galvaniz Direk, IP65
- Opsiyon** → Direk Yüksekliği: 3000 - 6000 mm

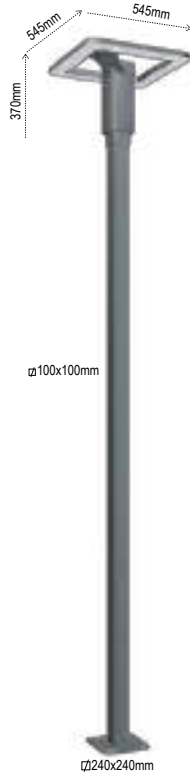

Gordion

Ø240x240mm

Kod	Güç (W)	Renk Sıcaklığı (K)	Direk Boyutu (mm)	Fiyat
209946	30	4000	4500	685,00\$
209947	40	4000	4500	685,00\$
209948	50	4000	4500	685,00\$
209949	60	4000	4500	685,00\$

- Özellikler** → Alüminyum, Galvaniz Direk, IP65
- Opsiyon** → Direk Yüksekliği: 3000 - 6000 mm

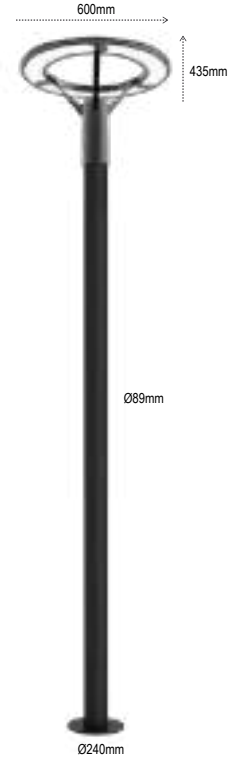

Troya G2

Ø240mm

Kod	Güç (W)	Renk Sıcaklığı (K)	Direk Boyutu (mm)	Fiyat
206776	25	4000	4500	850,50\$
206780	50	4000	4500	850,50\$
206783	75	4000	4500	850,50\$

- Özellikler** → Alüminyum, Galvaniz Direk, IP65
- Opsiyon** → Direk Yüksekliği: 3000 - 6000 mm





▽ 160x160mm

Larissa

Yeni Ürün

Kod	Güç (W)	Renk Sıcaklığı (K)	Direk Boyutu (mm)	Fiyat
212305	20	3000	2000	205,00\$
212306	30	3000	2500	269,00\$

- Özellikler  Alüminyum  Temperli Cam  IP65
- Opsiyonlar  DALI  Marin Boya



Ø115mm

Ø160mm

Terna

Yeni Ürün

Kod	Güç (W)	Renk Sıcaklığı (K)	Direk Boyutu (mm)	Fiyat
212307	20	3000	2000	192,00\$
212308	30	3000	2500	251,00\$

- Özellikler  Alüminyum  Temperli Cam  IP65
- Opsiyonlar  DALI  Marin Boya

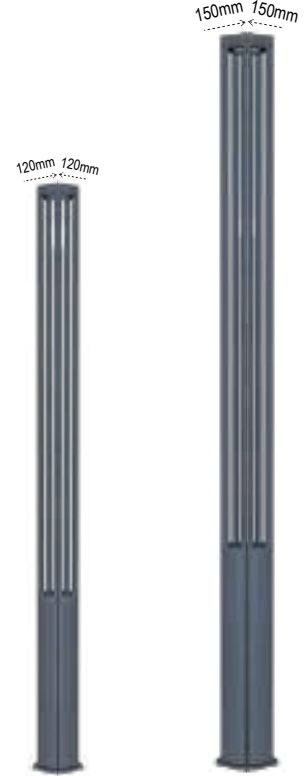

Ø165x165mm

Ø205x205mm

Pila

Yeni Ürün

Kod	Güç (W)	Renk Sıcaklığı (K)	Direk Boyutu (mm)	Fiyat
212309	20	3000	2000	205,00\$
212310	30	3000	2500	282,00\$

- Özellikler  Alüminyum  Temperli Cam  IP65
- Opsiyonlar  DALI  Marin Boya
-  Direk Yüksekliği: 2500-4000 mm



Ø300mm

Luzon

Kod	Güç (W)	Renk Sıcaklığı (K)	Direk Boyutu (mm)	Fiyat
109736	40	4000	2500	725,00\$

- Özellikler  Alüminyum  IP54



Ø100mm

Dara

Yeni Ürün

Kod	Güç (W)	Renk Sıcaklığı (K)	Direk Boyutu (mm)	Fiyat
212352	2x15	3000	2500	540,00\$

- Özellikler  Alüminyum  IP65



Ø220x220mm

Milas

Kod	Güç (W)	Renk Sıcaklığı (K)	Direk Boyutu (mm)	Fiyat
108500	100	4000	2500	901,00\$

- Özellikler  Alüminyum  IP65

* Özel ölçüler için satış ekibimiz ile iletişime geçiniz.



Cauna

Yeni Ürün

Kod	Güç (W)	Renk Sıcaklığı (K)	Direk Boyutu (mm)	Fiyat
212298	50	4000	2500	805,00\$

Özellikler Alüminyum IP54

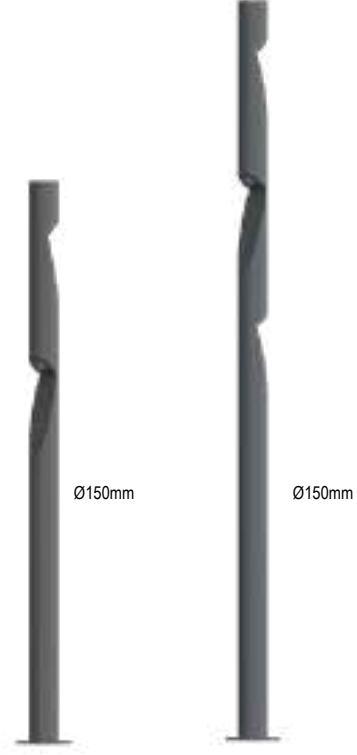

Sidyma

Yeni Ürün

Kod	Güç (W)	Renk Sıcaklığı (K)	Direk Boyutu (mm)	Fiyat
212301	2x15	4000	3000	499,00\$
212300	3x15	4000	4000	589,00\$

Özellikler Alüminyum IP65

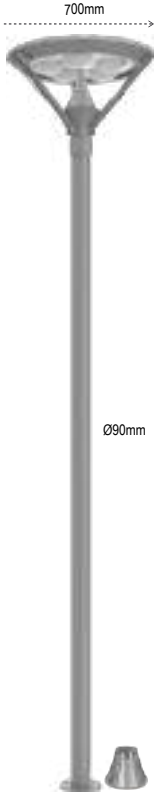

Limra

Kod	Güç (W)	Renk Sıcaklığı (K)	Direk Boyutu (mm)	Fiyat
108606 38 (3'lü)		4000	4500	631,00\$
108605 80 (5'li)		4000	4500	820,00\$

Özellikler IP54

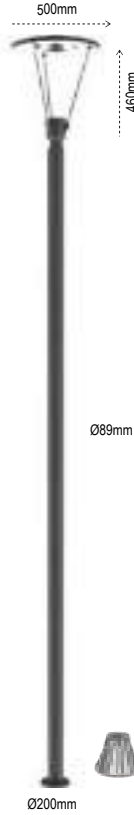

Petra

Kod	Güç (W)	Renk Sıcaklığı (K)	Direk Boyutu (mm)	Fiyat
107882	50	4000	4500	730,00\$

Özellikler IP65

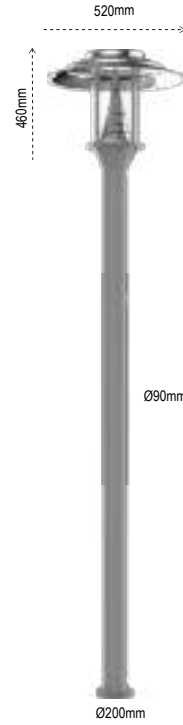

Evaled

Kod	Güç (W)	Renk Sıcaklığı (K)	Direk Boyutu (mm)	Fiyat
108610	40	4000	3500	706,00\$

Özellikler IP54





Lorma

Yeni Ürün

Kod	Güç (W)	Renk Sıcaklığı (K)	Direk Boyutu (mm)	Koli Adedi	Fiyat
212286	30	4000	4000	1	691,00\$
212288	2x30	4000	4000	1	1.050,00\$

Özellikler  Alüminyum  Galvaniz Direk  IP65

Opsiyonlar  DALI  Marin Boya



Gamon

Yeni Ürün

Kod	Güç (W)	Renk Sıcaklığı (K)	Direk Boyutu (mm)	Koli Adedi	Fiyat
212289	30	4000	4000	1	666,00\$

Özellikler  Alüminyum  Temperli Cam  Galvaniz Direk  IP65

Opsiyonlar  DALI  Marin Boya

 Direk Yüksekliği: 4000 - 6000 mm



Kedria

Yeni Ürün

Kod	Güç (W)	Renk Sıcaklığı (K)	Direk Boyutu (mm)	Koli Adedi	Fiyat
212291	50+100	4000	10000	1	2.730,00\$

Özellikler  Alüminyum  Temperli Cam  Galvaniz Direk  IP65

Opsiyonlar  DALI  Marin Boya

Lagina

Yeni Ürün

Kod	Güç (W)	Renk Sıcaklığı (K)	Direk Boyutu (mm)	Koli Adedi	Fiyat
212350	100	4000	10000	1	2.990,00\$
212293	50+100	4000	10000	1	3.120,00\$

Özellikler  Alüminyum  Temperli Cam  Galvaniz Direk  IP65

Opsiyonlar  DALI  Marin Boya

Teos

Yeni Ürün

Kod	Güç (W)	Renk Sıcaklığı (K)	Direk Boyutu (mm)	Koli Adedi	Fiyat
212295	40	4000	4000	1	850,00\$
212297	3x40	4000	4000	1	1.180,00\$

Özellikler  Alüminyum  Temperli Cam  Galvaniz Direk  IP65

Opsiyonlar  DALI  Marin Boya

 Direk Yüksekliği: 4000 - 6000 mm

* Özel ölçüler için satış ekibimiz ile iletişime geçiniz.

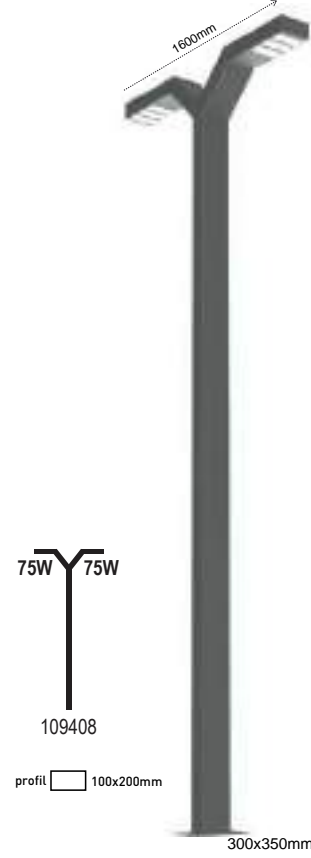
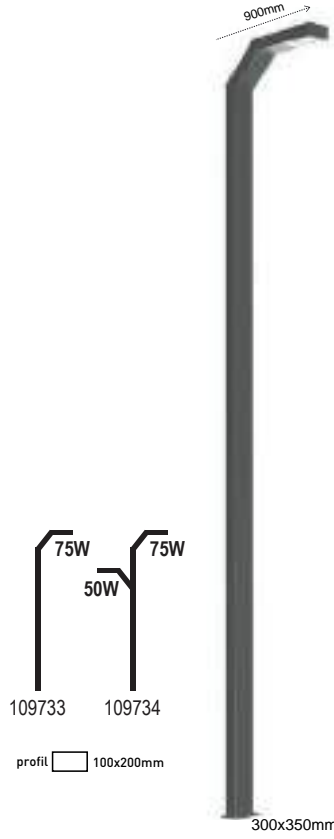
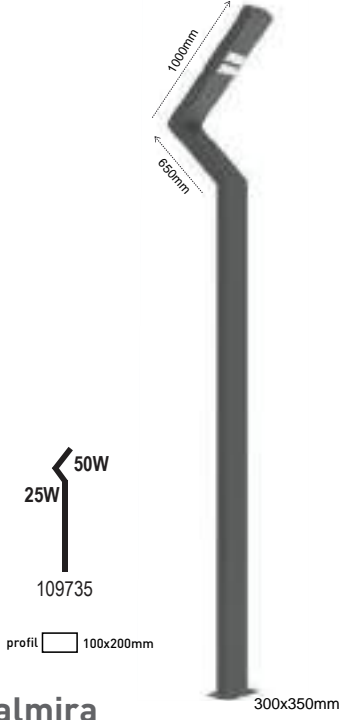

Palmira

Kod	Güç (W)	Renk Sıcaklığı (K)	Direk Boyutu (mm)	Fiyat
109735	50+25	4000	4500	1.418,00\$

- Özellikler: Alüminyum, IP65
Opsiyon: Direk Yüksekliği: 3000 - 6000 mm

Kod	Güç (W)	Renk Sıcaklığı (K)	Direk Boyutu (mm)	Fiyat
109733	75	4000	6000	1.619,00\$
109734	50+75	4000	6000	1.970,00\$

- Özellikler: Alüminyum, IP65
Opsiyon: Direk Yüksekliği: 3000 - 6000 mm

Kod	Güç (W)	Renk Sıcaklığı (K)	Direk Boyutu (mm)	Fiyat
109408	75+75	4000	6000	2.223,00\$

- Özellikler: Alüminyum, IP65
Opsiyon: Direk Yüksekliği: 3000 - 6000 mm

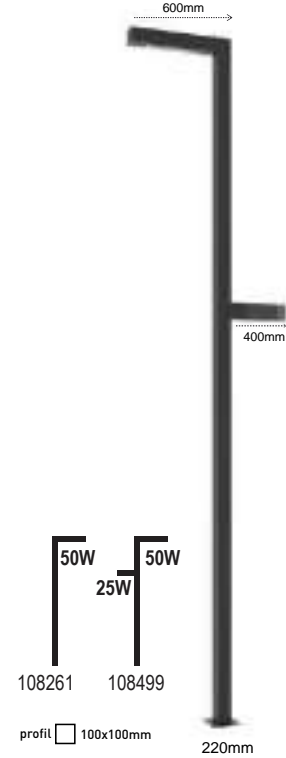
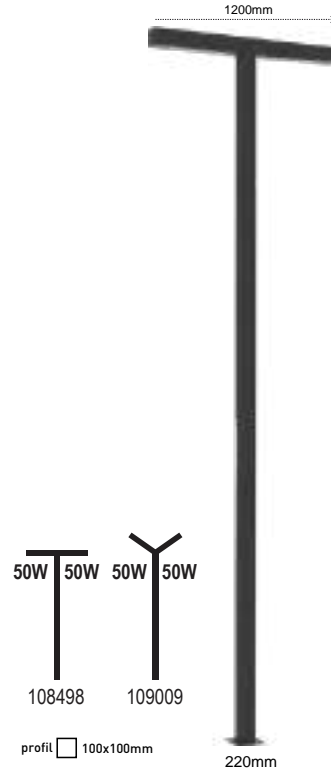
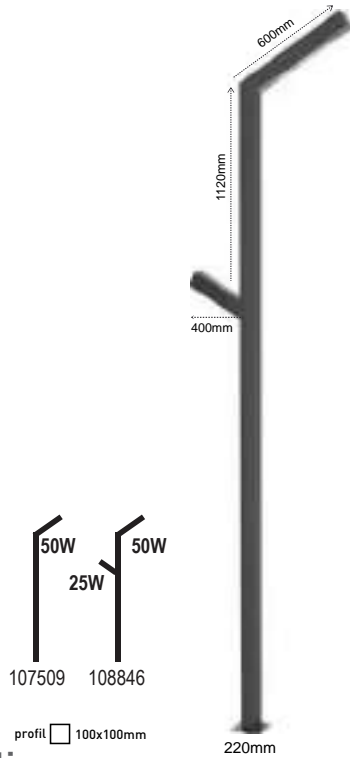

Olimpos

Kod	Güç (W)	Renk Sıcaklığı (K)	Direk Boyutu (mm)	Fiyat
107509	50	4000	4500	744,00\$
108846	50+25	4000	4500	891,00\$

- Özellikler: Alüminyum, IP65
Opsiyon: Direk Yüksekliği: 3000 - 6000 mm

Kod	Güç (W)	Renk Sıcaklığı (K)	Direk Boyutu (mm)	Fiyat
108498	50+50	4000	4500	1.043,00\$

- Özellikler: Alüminyum, IP65
Opsiyon: Direk Yüksekliği: 3000 - 6000 mm

Kod	Güç (W)	Renk Sıcaklığı (K)	Direk Boyutu (mm)	Fiyat
108261	50	4000	4500	744,00\$
108499	50+25	4000	4500	891,00\$

- Özellikler: Alüminyum, IP65
Opsiyon: Direk Yüksekliği: 3000 - 6000 mm



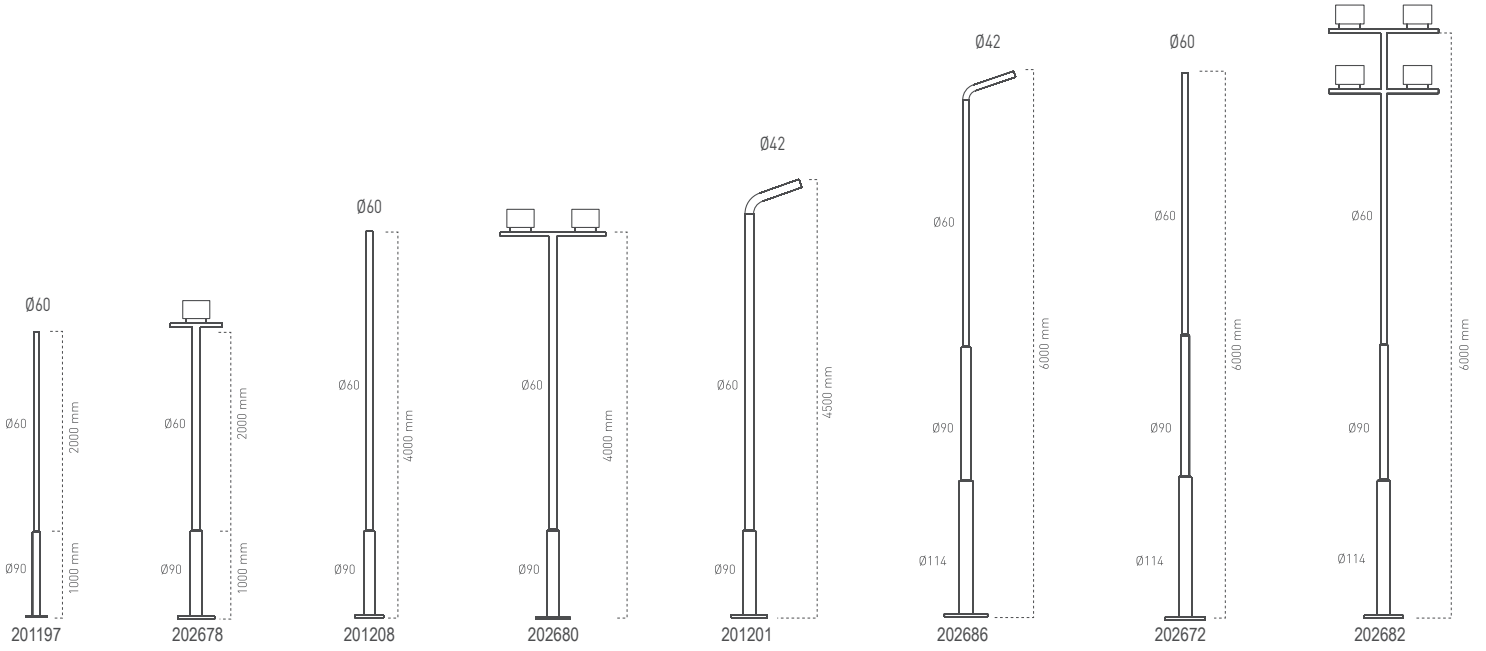

Yol, Bahçe ve Projektör Direkleri

Kod	Tanım	Koli Adedi	Fiyat
201197	3m Kademeli Boru Direk	1	166,30\$
202678	3m 1 Projektörlük Boru Direk	1	176,50\$
201208	4m Kademeli Boru Direk	1	186,70\$
202680	4m 2 Projektörlük Boru Direk	1	198,00\$

Özellikler  Metal  IP65

Kod	Tanım	Koli Adedi	Fiyat
201201	4,5m Sokak Lamba Direği	1	210,20\$
202686	6m Sokak Lamba Direği	1	343,90\$
202672	6m Kademeli Boru Direk	1	343,90\$
202682	6m 4 Projektörlük Direk	1	359,20\$
312688	Ankraj 250mm Polyester	1	14,30\$

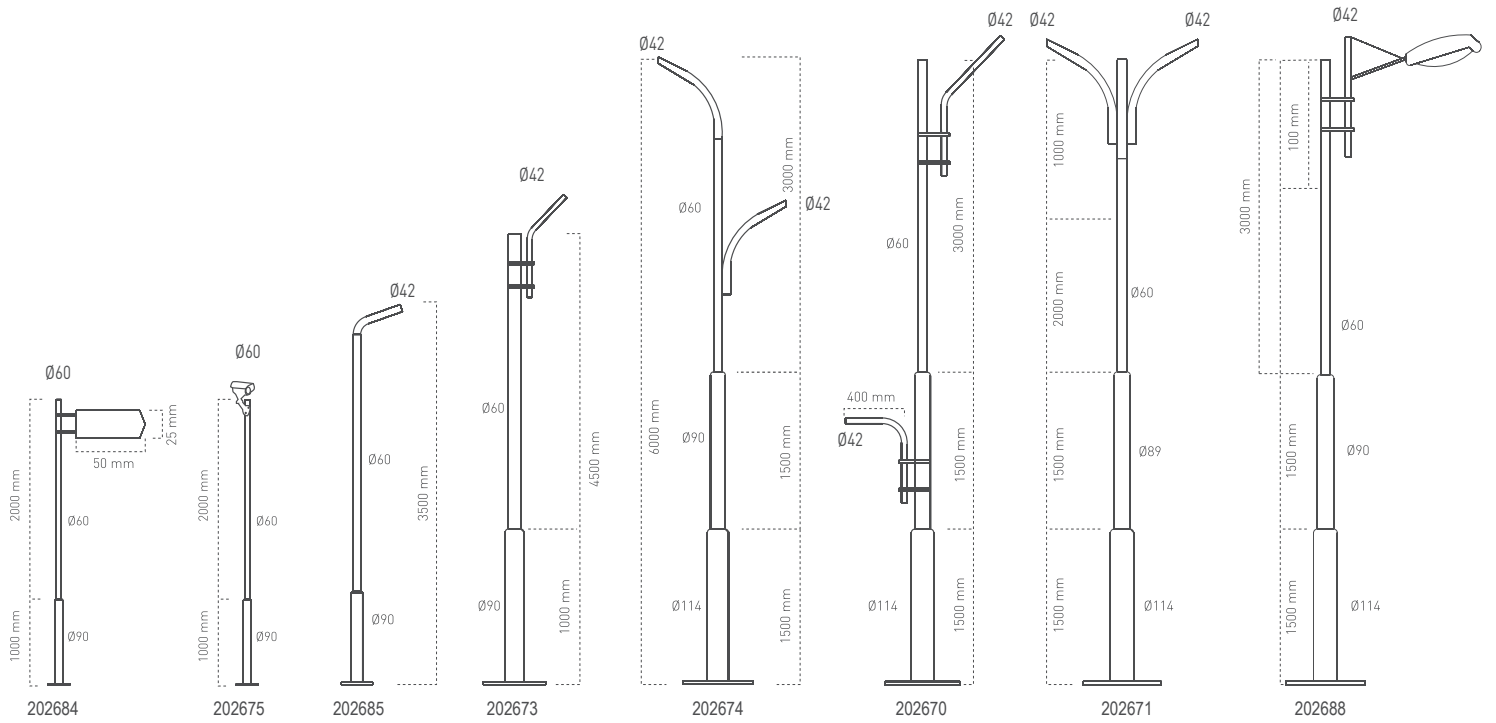

Yol, Bahçe ve Projektör Direkleri

Kod	Tanım	Koli Adedi	Fiyat
202684	3m Sokak Direği	1	190,80\$
202675	3m Kamera Direği	1	190,80\$
202685	3,5m Sokak Lamba Direği	1	190,80\$
202673	4,5m 1xArmatür Direği	1	211,20\$
312688	Ankraj 250mm Polyester	1	14,30\$

Özellikler  Metal  IP65

Kod	Tanım	Koli Adedi	Fiyat
202674	6m 2xArmatür Direği	1	359,20\$
202670	6m Çift Armatür Direği	1	382,70\$
202671	6m 2xKonsol Direği	1	359,20\$
202688	6m Armatür Direği	1	343,90\$
312688	Ankraj 250mm Polyester	1	14,30\$



Bali / Maldiv

Kod	Tip	Güç (W)	Renk Sıcaklığı (K)	Boyutlar (mm)	Koli Adedi	Fiyat
108870	Bali	18	4000	750	1	179,00\$
108872	Maldiv	18	4000	750	1	179,00\$

Özellikler Alüminyum IP65



Malta / Santorini

Kod	Tip	Güç (W)	Renk Sıcaklığı (K)	Boyutlar (mm)	Koli Adedi	Fiyat
108871	Malta	2x18	4000	750	1	285,00\$
108873	Santorini	2x18	4000	750	1	285,00\$

Özellikler Alüminyum IP65

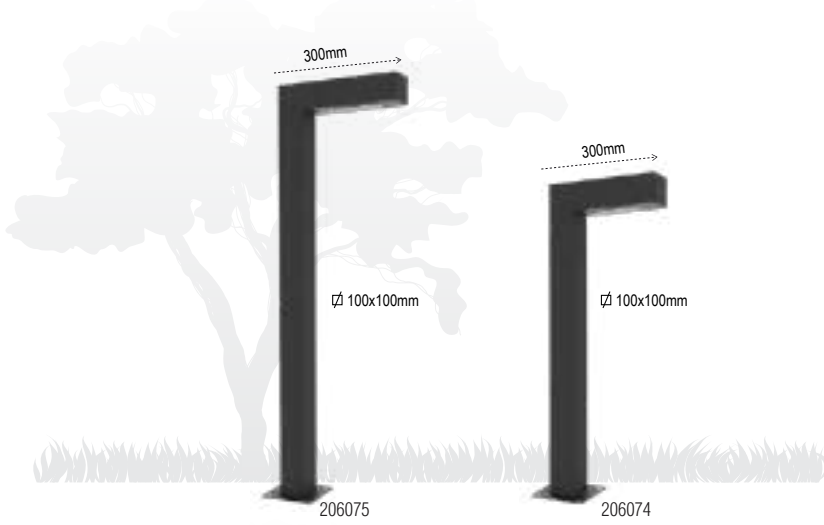

Olimpos Med

Kod	Güç (W)	Renk Sıcaklığı (K)	Boyutlar (mm)	Koli Adedi	Fiyat
206074	14	4000	600	1	138,00\$
206075	18	4000	1000	1	142,50\$

Özellikler Alüminyum IP65



Pega / Dara

Yeni Ürün

Kod	Tip	Güç (W)	Renk Sıcaklığı (K)	Boyutlar (mm)h	Koli Adedi	Fiyat
108878	Pega	18	4000	750	1	188,00\$
212285	Dara	2x5	3000	1000	1	290,00\$

Özellikler Alüminyum IP65





Alberi

Kod	Güç (W)	Renk Sıcaklığı (K)	Boyutlar (mm)	Koli Adedi	Fiyat
208554	6	3000	500	1	65,30 \$
208555	6	3000	700	1	70,40 \$

Özellikler  Alüminyum  IP54



Belise

Kod	Güç (W)	Renk Sıcaklığı (K)	Boyutlar (mm)	Koli Adedi	Fiyat
208530	6	3000	500	1	65,30 \$
208531	6	3000	750	1	70,40 \$

Özellikler  Alüminyum  IP54



Ayers

Kod	Güç (W)	Renk Sıcaklığı (K)	Boyutlar (mm)	Koli Adedi	Fiyat
208542	6	3000	500	1	80,60 \$
208543	6	3000	800	1	88,70 \$

Özellikler  Alüminyum  IP54



Pila

Kod	Güç (W)	Renk Sıcaklığı (K)	Boyutlar (mm)	Koli Adedi	Fiyat
209928	12	3000	800	1	166,20\$

Özellikler Alüminyum IP54



Terna

Kod	Güç (W)	Renk Sıcaklığı (K)	Boyutlar (mm)	Koli Adedi	Fiyat
209931	12	3000	800	1	126,30\$

Özellikler Alüminyum IP54





Larissa

Kod	Güç (W)	Renk Sıcaklığı (K)	Boyutlar (mm)	Koli Adedi	Fiyat
212979	12	3000	800	1	124,00\$

Özellikler Alüminyum IP65



Luzon 2

-  **IP66, Toz ve Su Almaz**
-  **Kamaşma Önleyici Optik Dizayn**
-  **Alüminyum Gövde**

Opsiyonlar,

- * RAL9005, RAL7043
- * DALI
- * Marin Boya



Luzon IP66

Kod	Güç (W)	Renk Sıcaklığı (K)	Boyutlar (mm)	Koli Adedi	Fiyat
115479	14	4000	655	1	140,00\$

Özellikler  Alüminyum  IP66



Luzon / Luzon 2

Kod	Güç (W)	Renk Sıcaklığı (K)	Boyutlar (mm)	Koli Adedi	Fiyat
109027	20	4000	750	1	234,00\$
110753	14	4000	655	1	120,00\$

Özellikler  Alüminyum  IP54



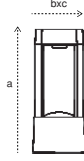

Alberi

Kod	Güç (W)	Renk Sıcaklığı (K)	Boyutlar (mm)axbxc	Koli Adedi	Fiyat
208553	6	3000	250x100x100	1	56,10\$

Özellikler  Alüminyum  IP54

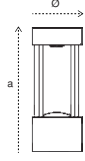

Belise

Kod	Güç (W)	Renk Sıcaklığı (K)	Boyutlar (mm)axØ	Koli Adedi	Fiyat
208529	6	3000	250x100	1	56,10\$

Özellikler  Alüminyum  IP54

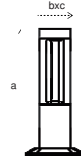

Ayers

Kod	Güç (W)	Renk Sıcaklığı (K)	Boyutlar (mm)axbxc	Koli Adedi	Fiyat
208541	6	3000	250x70x70	1	71,40\$

Özellikler  Alüminyum  IP54

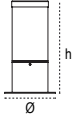

Tino

Kod	Güç (W)	Renk Sıcaklığı (K)	Boyutlar (mm)axh	Koli Adedi	Fiyat
110709	E27	-	170x310	1	70,00\$

Özellikler  Alüminyum  IP54

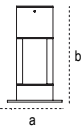

Alinda

Kod	Güç (W)	Renk Sıcaklığı (K)	Boyutlar (mm)axb	Koli Adedi	Fiyat
109401	15	400	200x310	8	131,00\$

Özellikler  Alüminyum  IP65

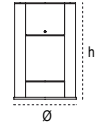

Pega

Kod	Güç (W)	Renk Sıcaklığı (K)	Boyutlar (mm)axh	Koli Adedi	Fiyat
109403	15	400	200x310	2	131,00\$

Özellikler  Alüminyum  IP65

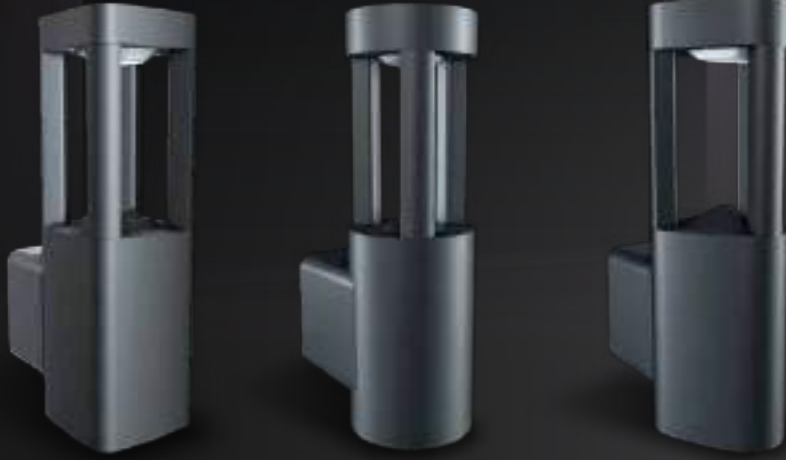

209856



209857



208562

Alberi

Kod	Tip	Güç (W)	Renk Sıcaklığı (K)	Boyutlar (mm)axbxc	Koli Adedi	Fiyat
208562	-	6	3000	220x70x70	1	70,40\$
209856	Down	6	3000	160x70	1	53,30\$
209857	Up / Down	12	3000	240x70	1	77,55\$

Özellikler Alüminyum IP54

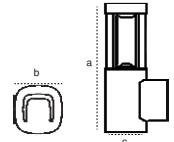

209858



209859



208538

Belise

Kod	Tip	Güç (W)	Renk Sıcaklığı (K)	Boyutlar (mm)Øxh	Koli Adedi	Fiyat
208538	-	6	3000	70x220	1	70,40\$
209858	Down	6	3000	70x160	1	53,30\$
209859	Up / Down	12	3000	70x240	1	77,55\$

Özellikler Alüminyum IP54

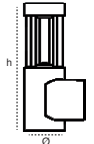

209860



209865



208550

Ayers

Kod	Tip	Güç (W)	Renk Sıcaklığı (K)	Boyutlar (mm)axbxc	Koli Adedi	Fiyat
208550	-	6	3000	220x70x70	1	88,70\$
209860	Down	6	3000	160x70	1	53,30\$
209865	Up / Down	12	3000	240x70	1	77,55\$

Özellikler Alüminyum IP54

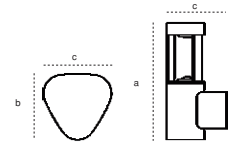



Carla

Kod	Güç (W)	Renk Sıcaklığı (K)	Boyutlar (mm)axbxc	Koli Adedi	Fiyat
207106	2xGu10	-	150x93x70	1	39,50 \$

Özellikler  Alüminyum  IP44

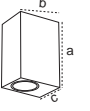

Vasco

Kod	Güç (W)	Renk Sıcaklığı (K)	Boyutlar (mm)axbxc	Koli Adedi	Fiyat
207108	2x4	3000	162x90x58	1	39,50 \$

Özellikler  Alüminyum  IP44

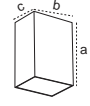

Santos

Kod	Güç (W)	Renk Sıcaklığı (K)	Boyutlar (mm)axbxc	Koli Adedi	Fiyat
207110	2x3	3000	176x111x62	1	39,90 \$

Özellikler  Alüminyum  IP44

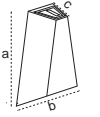

Dura

Kod	Güç (W)	Renk Sıcaklığı (K)	Boyutlar (mm)axbxc	Koli Adedi	Fiyat
208145	2x4	3000	160x90x58	1	39,50 \$

Özellikler  Alüminyum  IP44

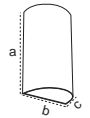

Işıl1 / Işıl2

Kod	Duy	Renk Sıcaklığı (K)	Boyutlar (mm)axb	Koli Adedi	Fiyat
110742	E27	-	120x180	8	50,00\$
110743	2xE27	-	120x300	6	63,00\$

Özellikler  Alüminyum  IP54

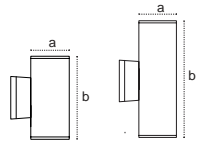

Tibat1 / Tibat2

Kod	Duy	Renk Sıcaklığı (K)	Boyutlar (mm)axb	Koli Adedi	Fiyat
110744	E27	-	120x180	8	52,00\$
110745	2xE27	-	120x305	6	65,00\$

Özellikler  Alüminyum  IP54

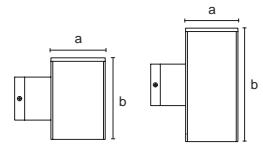



Mova (Sensörlü)

Kod	Güç (W)	Renk Sıcaklığı (K)	Boyutlar (mm)axh	Koli Adedi	Fiyat
115746	10	4000	255x185	20	29,10 \$
109228	10	6500	255x185	20	29,10 \$
111602	10	4000	255x185	20	29,10 \$

Özellikler PC IP54

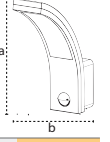

Mova

Kod	Güç (W)	Renk Sıcaklığı (K)	Boyutlar (mm)axh	Koli Adedi	Fiyat
111603	10	4000	255x185	20	21,70 \$

Özellikler PC IP54

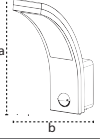

Ferra (Sensörlü)

Kod	Güç (W)	Renk Sıcaklığı (K)	Boyutlar (mm)axh	Koli Adedi	Fiyat
113599	20	4000	244x100	10	47,95 \$

Özellikler PC IP54

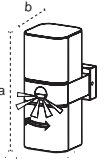

Tilva (Sensörlü)

Kod	Güç (W)	Renk Sıcaklığı (K)	Boyutlar (mm)axh	Koli Adedi	Fiyat
113596	20	4000	250x80	20	47,95 \$

Özellikler PC IP65

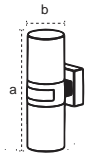

Grada (Sensörlü)

Kod	Güç (W)	Renk Sıcaklığı (K)	Boyutlar (mm)axb	Koli Adedi	Fiyat
113600	2x10	4000	156,3x75	8	53,00 \$

Özellikler Alüminyum IP65

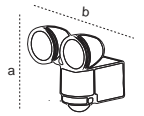

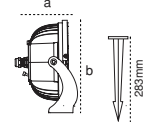

Santa

Çimen / Bahçe Armatürü

Kod	Güç (W)	Renk Sıcaklığı (K)	Boyutlar (mm)axb	Koli Adedi	Fiyat
206767	15	4000	185x160x80	1	164,50\$
206768	15	6500	185x160x80	1	164,50\$
206770	20	4000	185x160x80	1	164,50\$
206771	20	6500	185x160x80	1	164,50\$
206773	37	4000	185x160x80	1	197,25\$
206774	37	6500	185x160x80	1	197,25\$

Özellikler Alüminyum IP65

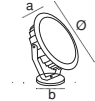

Grasled

Çimen / Bahçe Armatürü

Kod	Güç (W)	Renk Sıcaklığı (K)	Boyutlar (mm)axb	Koli Adedi	Fiyat
209920	3	4000	110x75x75	1	38,80 \$
209921	3	6500	110x75x75	1	38,80 \$
209923	6	4000	150x122x1100	1	67,50 \$
209924	6	6500	150x122x1100	1	67,50 \$
209926	9	4000	150x122x1100	1	77,60 \$
209927	9	6500	150x122x1100	1	77,60 \$

Özellikler Alüminyum IP65

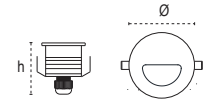

Oscaled

Duvar Armatürü

Kod	Güç (W)	Renk Sıcaklığı (K)	Boyutlar (mm)axh	Koli Adedi	Fiyat
206013	3	4000	59x60	1	104,60 \$

Özellikler Alüminyum IP65

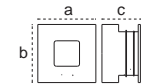

Escaled

Duvar Armatürü

Kod	Güç (W)	Renk Sıcaklığı (K)	Boyutlar (mm)axbxc	Koli Adedi	Fiyat
205989	3	4000	85x85x45	1	110,70 \$

Özellikler Alüminyum IP65



Yer Gömme Ø80



Kod	Güç (W)	Renk Sıcaklığı (K)	Boyutlar (mm)axbxc	Koli Adedi	Fiyat
205998	3	4000	110x90x80	1	152,00 \$

Özellikler  Alüminyum  IP67



Yer Gömme Ø100



Kod	Güç (W)	Renk Sıcaklığı (K)	Boyutlar (mm)axbxc	Koli Adedi	Fiyat
206001	6	4000	115x110x105	1	190,80 \$

Özellikler  Alüminyum  IP67



Yer Gömme Ø150



Kod	Güç (W)	Renk Sıcaklığı (K)	Boyutlar (mm)axbxc	Koli Adedi	Fiyat
206004	6	4000	150x140x100	1	281,10 \$
206007	18	4000	150x140x100	1	281,10 \$
206010	27	4000	150x140x100	1	281,10 \$

Özellikler  Alüminyum  IP67



Pelsan



Tüm aydınlatma ihtiyaçlarınız için tek adres.

www.pelsan.com.tr

info@pelsan.com.tr | export@pelsan.com.tr

MERKEZ

Çerkeşli O.S.B.
İmes 5. Cadde No:12
Dilovası / Kocaeli - TÜRKİYE



[/PelsanAydinlatma](https://www.facebook.com/PelsanAydinlatma)



[pelsan-aydinlatma](https://www.linkedin.com/company/pelsan-aydinlatma)



[pelsan aydinlatma](https://www.youtube.com/channel/UCpelsan_aydinlatma)



[/pelsanaydinlatma](https://www.instagram.com/pelsanaydinlatma)



[/PelsanLight](https://twitter.com/PelsanLight)

T : +9(0850) 460 75 76

F : +9(0216) 364 60 15